

ZADATAK 6.

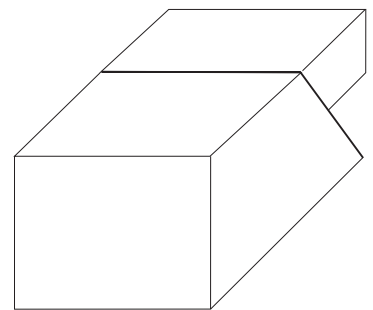
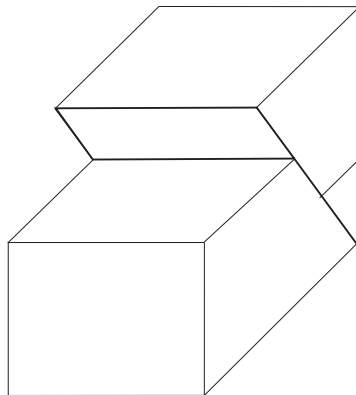
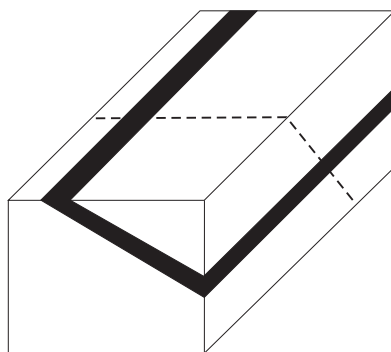
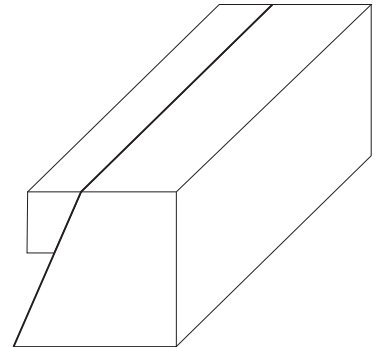
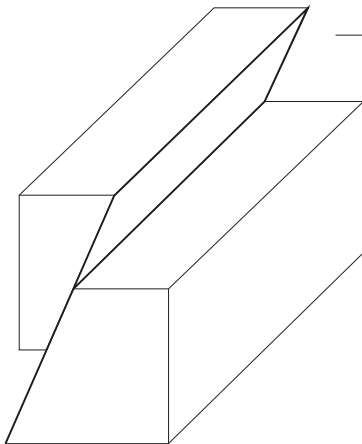
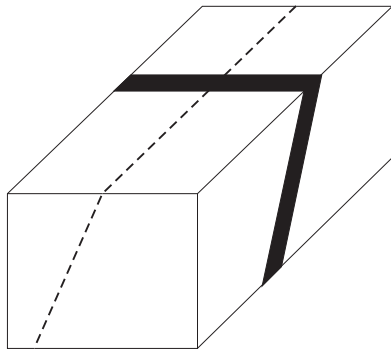
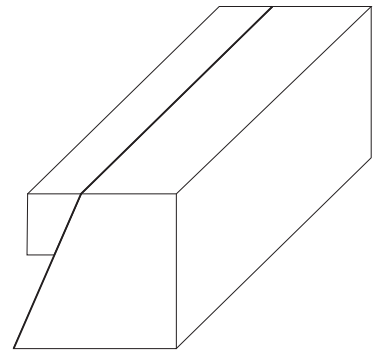
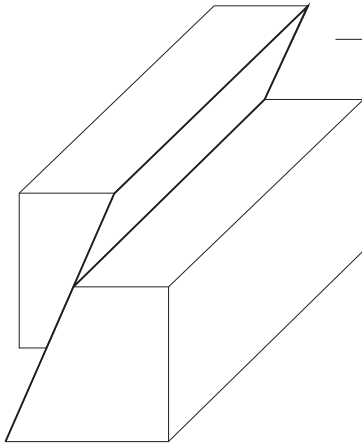
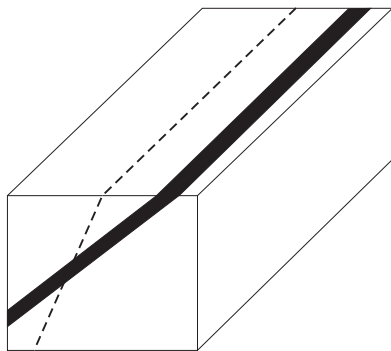
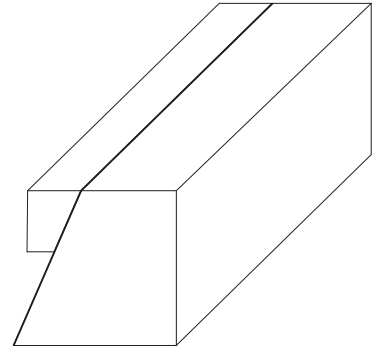
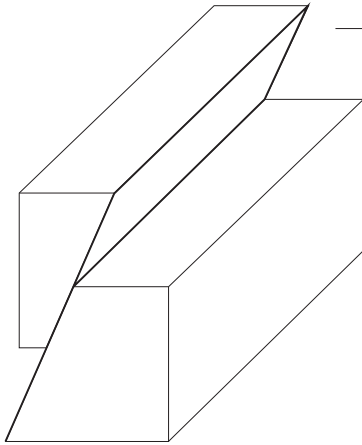
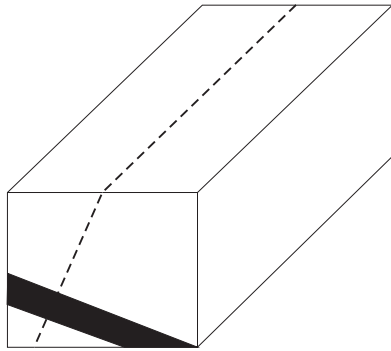

STUDENT _____