

IZMJENIČNE STRUJE

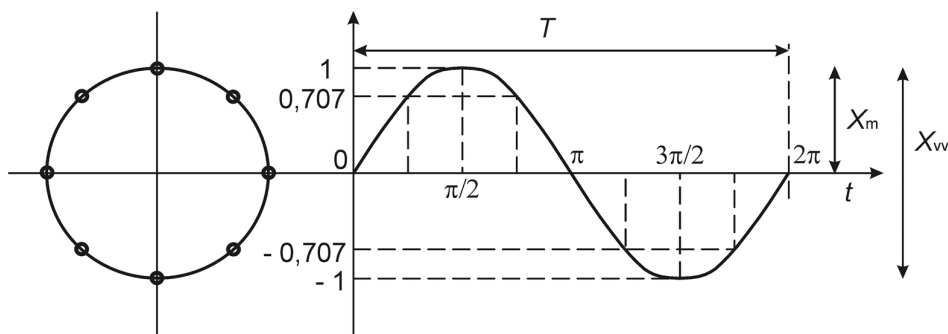

$$f = \frac{1}{T}$$

$$\omega = 2\pi f = \frac{2\pi}{T}$$

$$X_m = \frac{X_{\text{v}}}{2}$$

$$\omega t$$

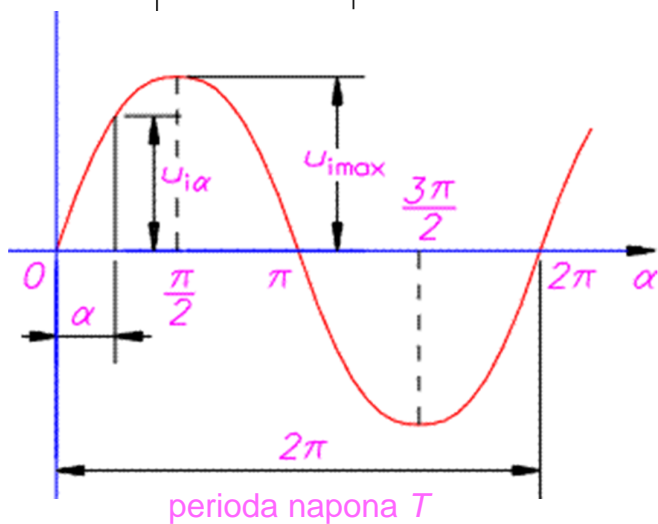

uz kutnu brzinu $\omega = \frac{\alpha}{t}$

kut je $\alpha = \omega \cdot t$

$$u_i = U_{i \max} \cdot \sin \omega t$$

Dobivanje sinusoide

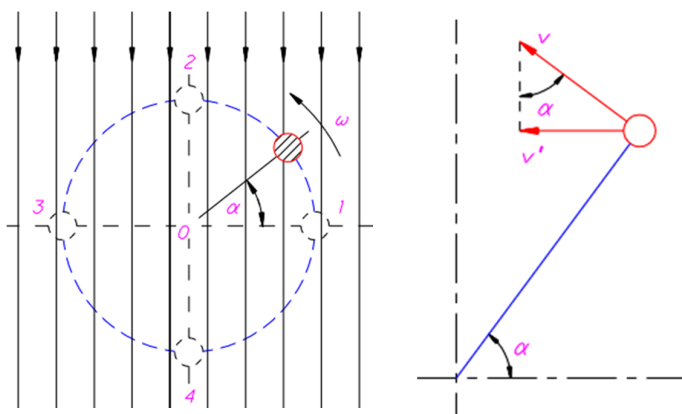
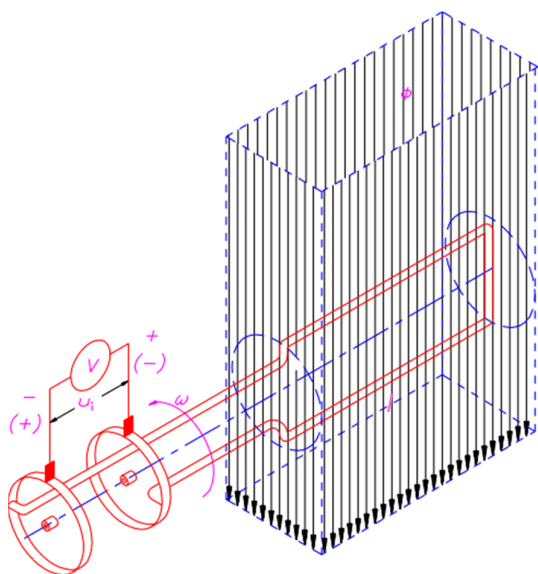

trenutna vrijednost inducirano napona

$$u_i = B \cdot l \cdot v' = B \cdot l \cdot v \cdot \sin \alpha \quad (\text{V})$$

uz $\alpha = \frac{\pi}{2}$ $\sin \alpha = 1$ i $U_{i \max} = B \cdot l \cdot v$

općenito vrijedi $u_i = U_{i \max} \cdot \sin \alpha$

Efektivna vrijednost sinusoide

rad za stalnu jakost struje

$$A = I^2 \cdot R \cdot t$$

rad za promjenjivu jakost struje

$$A = \int_0^t i^2 \cdot R \cdot dt$$

za jednak rad u oba slučaja \Rightarrow efektivna vrijednost izmjenične struje (I)

$$I_{ef} = \sqrt{\frac{1}{T} \int_0^T i^2(t) dt} \quad I(t) = I_m \sin \omega t$$

$$I_{ef} = \sqrt{\frac{1}{T} \int_0^T i^2(t) dt} = \sqrt{\frac{1}{T} \int_0^T (I_m \sin \omega t)^2 dt} = \sqrt{\frac{I_m^2}{T} \int_0^T \sin^2 \omega t \cdot dt} \quad \int \sin^2 ax dx = \frac{1}{2}x - \frac{1}{4a} \sin 2ax$$

$$I_{ef} = \sqrt{\frac{I_m^2}{T} \left(\frac{1}{2}t - \frac{1}{4\omega} \sin 2\omega t \right) \Big|_0^T} = I_{ef} = \sqrt{\frac{I_m^2}{T} \left(\frac{1}{2} \cdot T - \frac{1}{4\omega} \sin 2 \cdot \frac{2\pi}{T} \cdot T - \frac{1}{2} \cdot 0 + \frac{1}{4\omega} \sin 2 \cdot \frac{2\pi}{T} \cdot 0 \right)} =$$

$$I_{ef} = \sqrt{\frac{I_m^2}{T} \cdot \frac{T}{2}} = \frac{I_m}{\sqrt{2}} \quad I_{ef} = \frac{I_m}{\sqrt{2}}$$

odnosno za bilo koju sinusnu veličinu:

$$X_{ef} = \frac{X_m}{\sqrt{2}}$$

karakteristične vrijednosti izmjenične struje – efektivna i srednja vrijednost

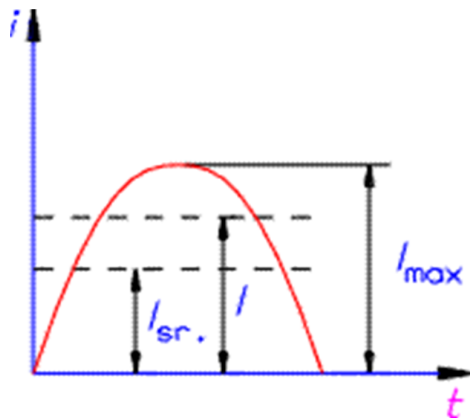

trenutne vrijednosti sinusnog valnog oblika izražene efektivnim vrijednostima

efektivne vrijednosti za sinusni valni oblik

$$I = I_{max} \cdot \frac{1}{\sqrt{2}}$$

$$U = U_{max} \cdot \frac{1}{\sqrt{2}}$$

$$i = \sqrt{2} \cdot I \cdot \sin \omega t$$

$$u = \sqrt{2} \cdot U \cdot \sin \omega t$$

temeljem količine naboja određuje se **srednja** vrijednost za sinusni valni oblik

$$I_{sr} = \frac{2I_{max}}{\pi} \quad U_{sr} = \frac{2U_{max}}{\pi}$$

Fazni pomak

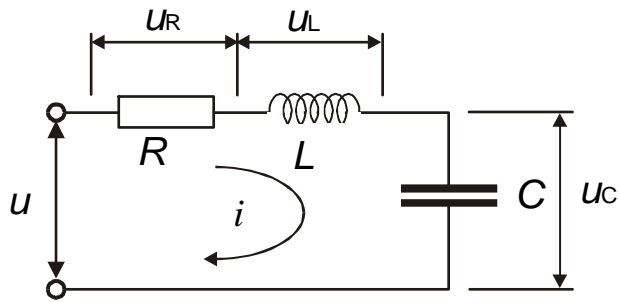

$$u_R = i \cdot R \quad u_L = L \frac{di}{dt} \quad u_C = \frac{1}{C} \int i \cdot dt$$

$$u = i \cdot R + L \frac{di}{dt} + \frac{1}{C} \int i \cdot dt$$

Izvor napona sa sinusnim oblikom
=> poteći će struja

$$i = I_{max} \cdot \sin(\omega t)$$

$$u_R = R \cdot I_{max} \sin(\omega t)$$

$$u_L = L \frac{dI_{max} \sin(\omega t)}{dt} = L \frac{d}{dt} I_{max} \sin(\omega t) = L \cdot I_{max} \frac{d}{dt} \sin(\omega t) = \underbrace{\omega L}_{\text{induktivni otpor } X_L} \cdot I_{max} \cos(\omega t)$$

$$u_L = X_L \cdot I_{max} \cos(\omega t)$$

$$u_C = \frac{1}{C} \int I_{max} \sin(\omega t) \cdot dt = \frac{1}{C} I_{max} \int \sin(\omega t) \cdot dt = \frac{1}{\underbrace{\omega \cdot C}_{\text{kapacitivni otpor } X_C}} I_{max} (-\cos(\omega t))$$

$$u_C = X_C \cdot I_{max} (-\cos(\omega t))$$

$$u = R \cdot I_{max} \sin(\omega t) + X_L \cdot I_{max} \cos(\omega t) + X_C \cdot I_{max} (-\cos(\omega t))$$

$$u = R \cdot I_{max} \sin(\omega t) + X_L \cdot I_{max} \sin(\omega t + 90) + X_C \cdot I_{max} \sin(\omega t - 90)$$

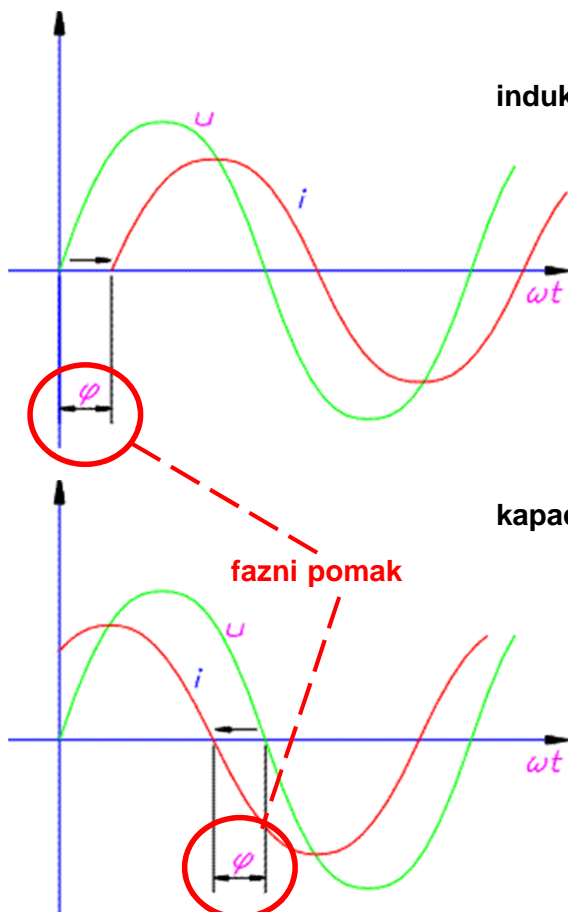

induktivni krug

$$u = \sqrt{2} \cdot U \cdot \sin \omega t$$

$$i = \sqrt{2} \cdot I \cdot \sin(\omega t - \varphi)$$

kapacitivni krug

$$u = \sqrt{2} \cdot U \cdot \sin \omega t$$

$$i = \sqrt{2} \cdot I \cdot \sin(\omega t + \varphi)$$

Rad i snaga izmjenične struje

rad u vremenu T

$$A = \int_0^T u \cdot i \cdot dt$$

snaga

$$P = \frac{1}{T} \int_0^T u \cdot i \cdot dt$$

$$P = \frac{1}{T} \int_0^T \sqrt{2} \cdot U \cdot \sin \omega t \cdot \sqrt{2} \cdot I \cdot \sin(\omega t - \varphi) \cdot dt$$

prividna snaga

$$S = U \cdot I \quad (\text{VA})$$

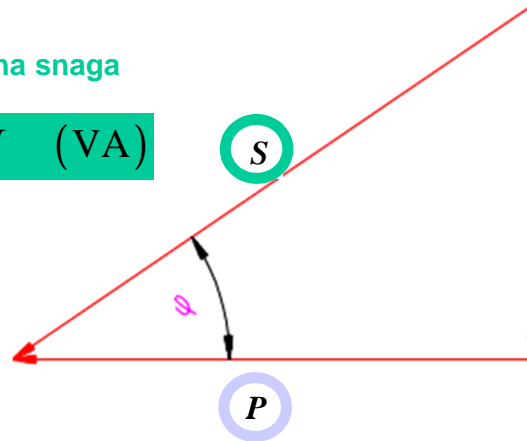

jalova snaga

$$Q = U \cdot I \cdot \sin \varphi \quad (\text{VAr})$$

radna snaga

$$P = U \cdot I \cdot \cos \varphi \quad (\text{W})$$

$\cos \varphi$ - faktor snage

trenutne vrijednosti snage za $\varphi = 0$

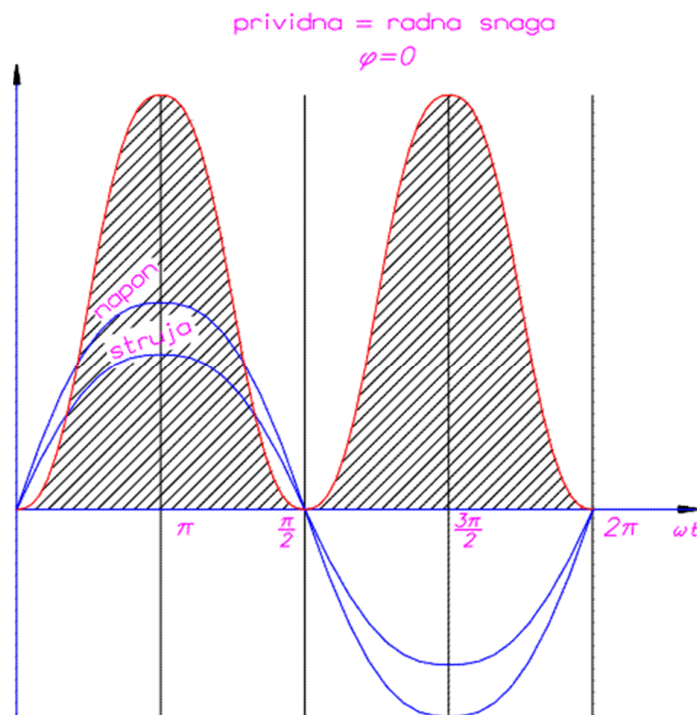

trenutne vrijednosti snage za $\varphi = 60^\circ$

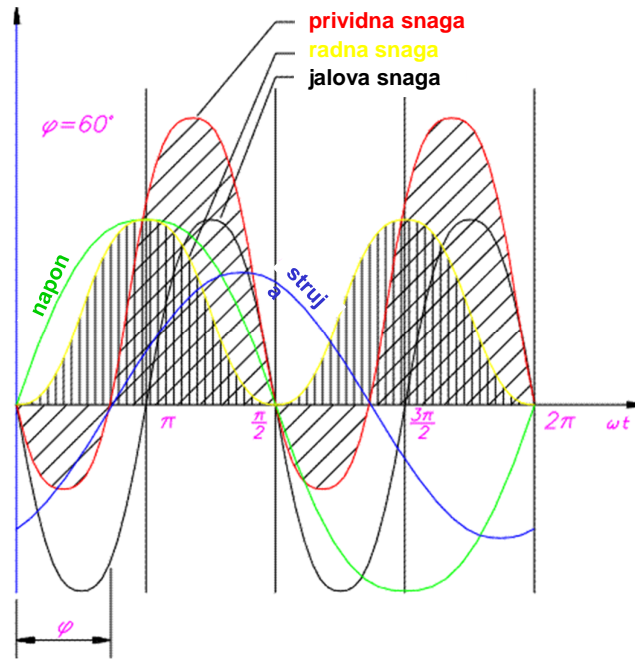

trenutne vrijednosti snage za $\varphi = 90^\circ (\pi/2)$

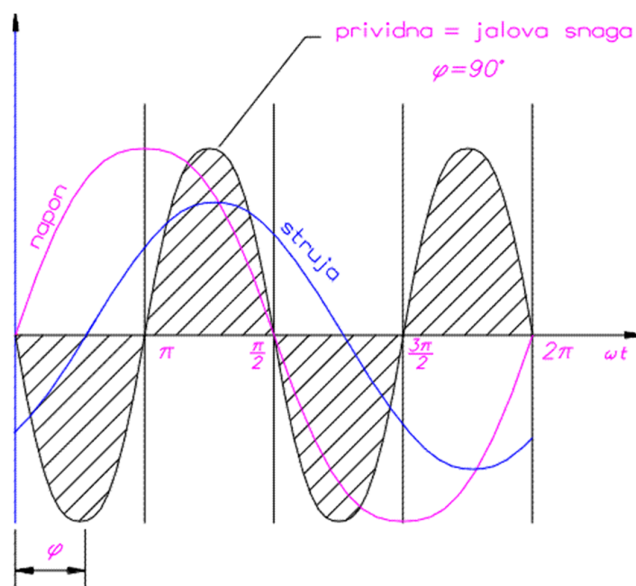

Pivovara (elektrana) proizvodi pivo i naplaćuje prodavaču (elektrodistributer).

Prodavač (elektrodistributer) servira i naplaćuje žednom korisniku (potrošač).



Više pjene \Rightarrow veća krigla ili više krigla za serviranje piva.

Prodavač ograničava količinu pjene ili naplaćuje serviranje pjene.

prikaz ~ struje trenutnim vrijednostima nepraktičan (vremenska domena)
 prikaz u sustavu realne i imaginarne osi \Rightarrow kazalo (vektor) s kutem $\omega t (\alpha)$
 svaka periodička funkcija - vektorski zbroj realne i imaginarne komponente

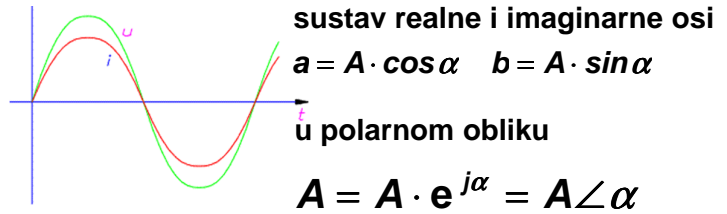
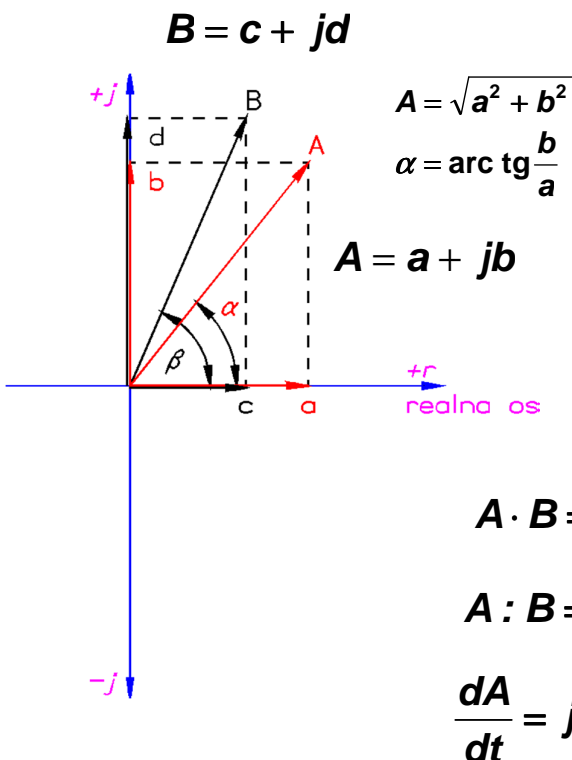

računske operacije

$$A + B = (a + c) + j(b + d)$$

$$A - B = (a - c) + j(b - d)$$

$$A \cdot B = (ac - bd) + j(ad + bc) = A \cdot B \cdot e^{j(\alpha + \beta)}$$

$$A : B = \frac{ac + bd}{c^2 + d^2} + j \frac{bc - ad}{c^2 + d^2} = \frac{A}{B} \cdot e^{j(\alpha - \beta)}$$

$$\frac{dA}{dt} = j\omega A \cdot e^{j(\omega t + \varphi)} \quad \int A \cdot dt = -j \frac{A}{\omega} \cdot e^{j(\omega t + \varphi)}$$

omski (R) strujni krug

$$\underline{U} = U + j0 = U\angle 0$$

$$I_R = I_R + j0 = I_R\angle 0$$

induktivni (L) strujni krug

$$\underline{U} = U + j0 = U\angle 0$$

$$I_L = 0 - jI_L = I_L\angle -90^\circ$$

kapacitivni (C) strujni krug

$$\underline{U} = U + j0 = U\angle 0$$

$$I_C = 0 + jI_C = I_C\angle 90^\circ$$

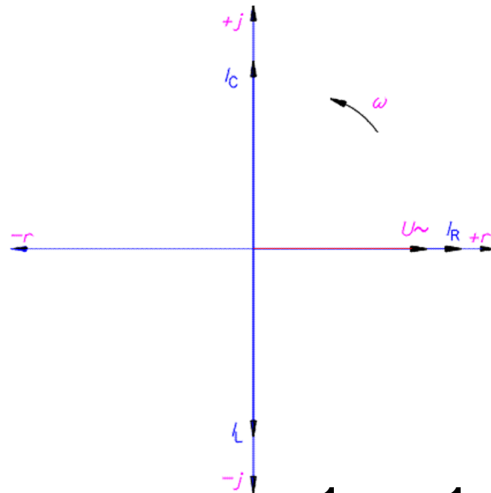
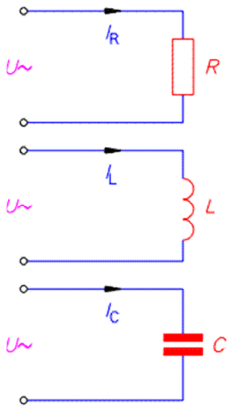

impedancija Z

$$Z = R + jX = Z\angle\varphi$$

$$Z = \sqrt{R^2 + X^2}$$

$$\varphi = \arctan \frac{X}{R}$$

admitancija Y

$$Y = \frac{1}{Z} = \frac{1}{R + jX} = \frac{R}{R^2 + X^2} - j \frac{X}{R^2 + X^2}$$

vrijede Ohmov

$$\underline{U} = \underline{I} \cdot \underline{Z}$$

i Kirchhoffovi zakoni

$$\underline{I} = \sum_{i=1}^n \underline{I}_i$$

$$0 = \sum_{i=1}^n \underline{U}_i$$

računske operacije sa sinusnim veličinama rezultiraju sinusnim veličinama

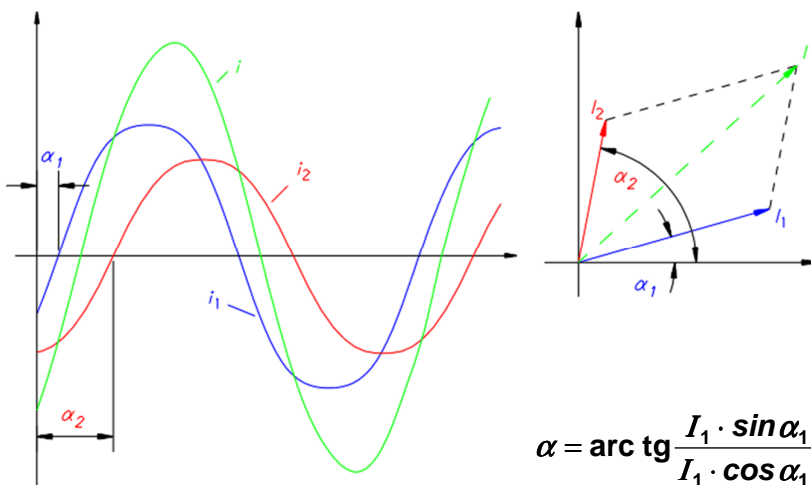

$$\alpha = \arctan \frac{I_1 \cdot \sin \alpha_1 + I_2 \cdot \sin \alpha_2}{I_1 \cdot \cos \alpha_1 + I_2 \cdot \cos \alpha_2}$$

$$i_1 = \sqrt{2} \cdot I_1 \cdot \sin(\omega t - \alpha_1)$$

$$I = \sqrt{(I_1 \cdot \cos \alpha_1 + I_2 \cdot \cos \alpha_2)^2 + (I_1 \cdot \sin \alpha_1 + I_2 \cdot \sin \alpha_2)^2}$$

$$i_2 = \sqrt{2} \cdot I_2 \cdot \sin(\omega t - \alpha_2)$$

$$i = i_1 + i_2 = \sqrt{2} \cdot I_1 \cdot \sin(\omega t - \alpha_1) + \sqrt{2} \cdot I_2 \cdot \sin(\omega t - \alpha_2)$$

prema Ohmovom zakonu za čisti induktivitet vrijedi

$$\underline{U} = \underline{I} \cdot \omega L$$

ponašanje induktivnog otpora u izmjeničnom strujnom krugu

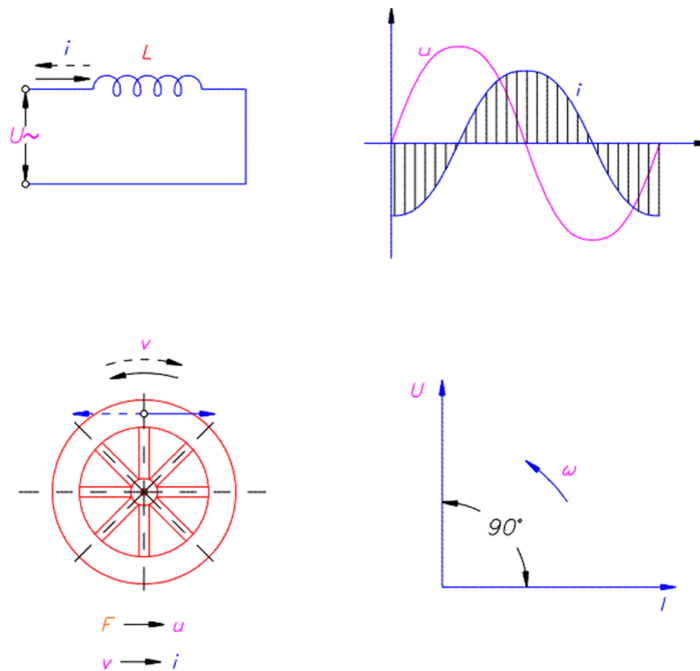

realna zavojnica (kao serijski spoj R i L)
u strujnom krugu

za \sim strujni krug $u \Rightarrow i$ trajno uz φ

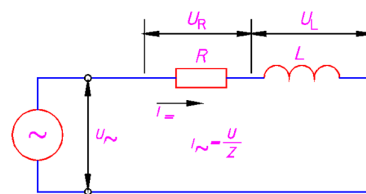
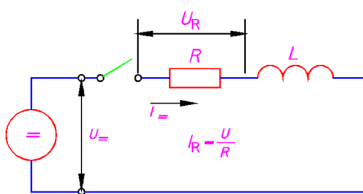

$$u_{\sim} = i \cdot R + L \frac{di}{dt} \quad \text{ako je}$$

$$i = \sqrt{2} \cdot I \cdot \sin \omega t$$

$$u_{\sim} = \sqrt{2} U \cdot \sin(\omega t + \varphi)$$

$$\frac{di}{dt} = \sqrt{2} \cdot I \cdot \omega \cdot \cos \omega t$$

tada vrijedi

$$U = I \cdot \sqrt{R^2 + X_L^2} = I \cdot Z$$

$$Z = \sqrt{R^2 + X_L^2}$$

$$\underline{Z} = R + jX_L = Z \cdot e^{j\varphi} = Z \angle \varphi$$

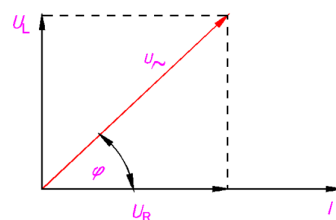
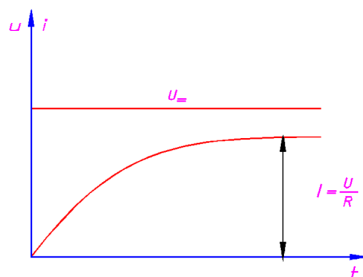

za = strujni krug

$$I = \frac{U_{\sim}}{R}$$

$$\varphi = \arctg \frac{X_L}{R} = \arctg \frac{\omega L}{R} \quad 0 \leq \varphi \leq \frac{\pi}{2}$$

za = struju

$$f=0 \Rightarrow X_L=0 \quad \varphi=0$$

$$\Rightarrow Z=R \Rightarrow U=IR$$

prijelazna pojava za istosmjerni napon

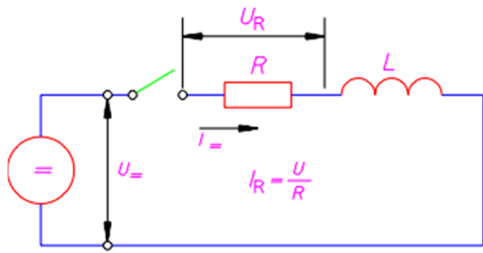

$$\text{za } t=0 \Rightarrow i=0 \quad \text{za } t=\infty \Rightarrow i=I=\frac{U}{R}$$

uvijek vrijedi

$$U = i \cdot R + L \frac{di}{dt} \quad \text{ili} \quad \frac{dt}{L} = \frac{di}{U - i \cdot R}$$

integriranjem

$$\frac{t}{L} = -\frac{1}{R} \cdot \ln(U - i \cdot R) + \ln k$$

$$i = \frac{U}{R} \left(1 - e^{-\frac{R}{L}t} \right) = I \left(1 - e^{-\frac{R}{L}t} \right)$$

$$\tau = \frac{L}{R}$$

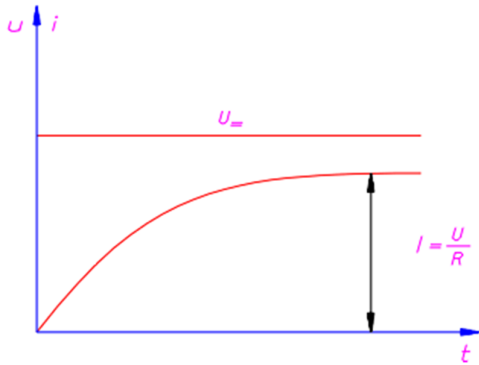

$$i = I \left(1 - e^{-\frac{t}{\tau}} \right)$$

prijelazne pojave za izmjenični napon

kod priključivanja induktivnog strujnog kruga na izvor izmjeničnog napona u na jakost struje značajno utječe početna vrijednost izmjeničnog napona

$$u = \sqrt{2} \cdot U \cdot \sin(\omega t + \alpha) = i \cdot R + L \frac{di}{dt} \quad \text{— nehomogena diferencijalna jednačba}$$

rješenje sadrži dvije pojave

simetričnu komponentu struje

$$i' = \frac{\sqrt{2} \cdot U}{Z} \sin(\omega t + \alpha - \varphi)$$

gdje je $\varphi = \arctg \frac{X_L}{R}$

asimetričnu komponentu struje

$$i'' = \frac{\sqrt{2} \cdot U}{Z} \cdot \sin(\alpha - \varphi) \cdot e^{-\frac{R}{L}t}$$

ukupna struja je

$$i = i' + i''$$

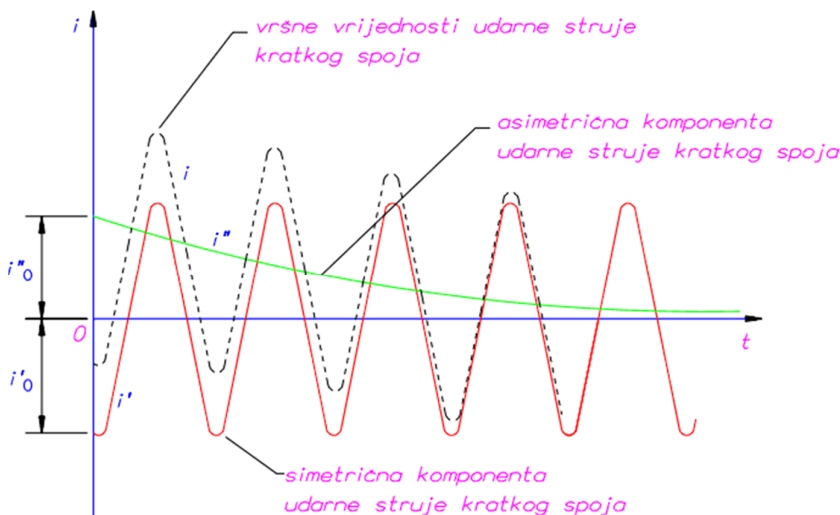

maksimalna vrijednost udarne struje kratkog spoja

$$i = 2 \cdot \frac{\sqrt{2} \cdot U}{Z}$$

pri prekidanju napajanja izmjeničnim naponom induktivnog strujnog kruga jednako ponašanje kao i pri prekidanju uz istosmjerno napajanje

mora biti zadovoljeno $i \cdot R + L \frac{di}{dt} = 0 \Rightarrow i = \sqrt{2} \cdot I \cdot \sin(\omega t - \varphi) \cdot e^{-\frac{R}{L}t}$

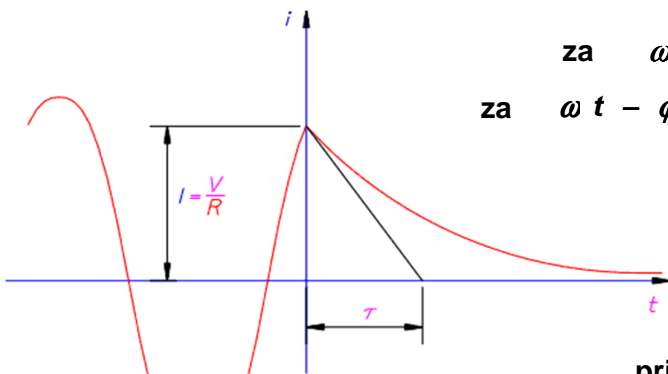

za $\omega t - \varphi = 0$ nema prijelazne pojave $i = 0$

za $\omega t - \varphi \neq 0$ prijelazna pojava kao za DC struju

$$i = I \cdot e^{-\frac{t}{\tau}}$$

$$i = \sqrt{2} \cdot I \cdot \sin(\omega t - \varphi) \cdot e^{-\frac{t}{\tau}}$$

pri tom je $\tau = \frac{L}{R}$ vremenska konstanta

uz trenutno prekidanje toka struje ($t = 0$) $\Rightarrow i_L \cdot u_L = \frac{1}{T_L} \cdot R \cdot \int i^2 \cdot dt \Rightarrow u_p = i_p \cdot \sqrt{\frac{L}{C}} = i_p \cdot Z_0$

i_L - trenutna vrijednost struje
 u_L - trenutna vrijednost napona
 T_L - vrijeme prekidanja

i - struja prelazne pojave
 i_p - veličina prekinute struje
 u_p - napon prekidanja

Z_0 - valni otpor

$$Z_0 = 5 \text{ k}\Omega \quad i_p = 5 \text{ A} \Rightarrow u_p = 25 \text{ kV}$$

KONDENZATOR U STRUJNOM KRUGU

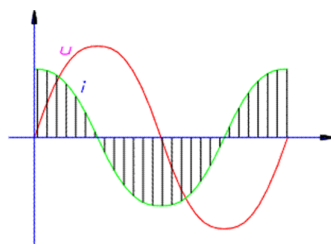
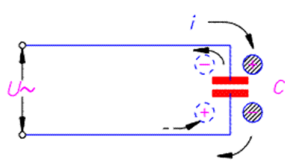

$$u = \sqrt{2} \cdot U \cdot \sin \omega t$$

$$i = \omega \cdot C \cdot \sqrt{2} \cdot U \cdot \sin\left(\omega t + \frac{\pi}{2}\right)$$

tjemena vrijednost struje
 struja prethodi naponu 90°

prema $I \cdot \sqrt{2} = \sqrt{2} \cdot U \cdot \omega \cdot C$

$$U = I \cdot \frac{1}{\omega C} = I \cdot X_C$$

slijedi $X_C = \frac{1}{\omega C}$

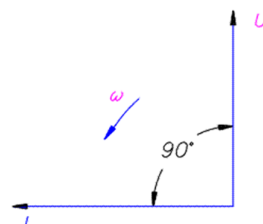
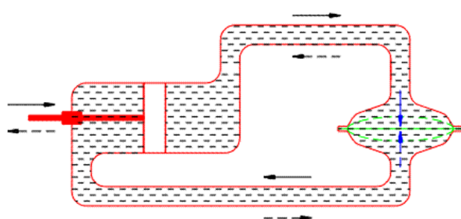

kapacitivni otpor
 kapacitivna reaktancija

~ napon \Rightarrow izmjenično nabijanje i izbijanje

\Rightarrow promjenjivo električno polje u dielektriku

\Rightarrow stalno prepolariziranje molekula

\Rightarrow zagrijavanje izolatora

\Rightarrow dielektrički gubici

gubici \Rightarrow ne ovise o vodljivosti izolatora (jednak karakter)

gubici \Rightarrow predstavljaju radnu komponentu

gubici \Rightarrow smanjenje faznog pomaka za kut δ

$$\varphi = \frac{\pi}{2} - \delta \quad \delta \text{ je malen te se izražava kao}$$

$$\operatorname{tg} \delta = \frac{I_{dg}}{I_C} \quad \begin{array}{l} I_{dg} - \text{struja dielektričkih gubitaka} \\ I_C - \text{struja kondenzatora} \end{array}$$

za = strujni krug

$$t = 0$$

$$u_C = 0 \quad i_C = \frac{U}{R}$$

$$t = \infty$$

$$u_C = U \quad i_C = 0$$

$$U = i_C \cdot R + \frac{1}{C} \int i_C \cdot dt = \text{konst.}$$

$$i_C = I \cdot e^{-\frac{t}{R \cdot C}} \quad \text{uz} \quad \tau = R \cdot C$$

$$i_C = I \cdot e^{-\frac{t}{\tau}}$$

$$u_C = U \left(1 - e^{-\frac{t}{\tau}} \right)$$

realni kondenzator (kao serijski spoj R i C)
u strujnom krugu

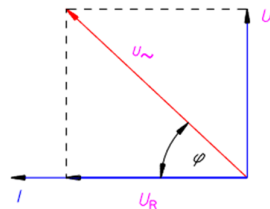
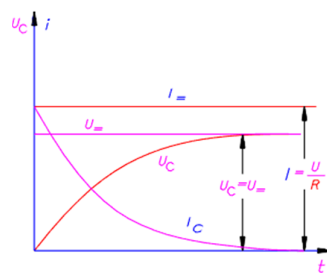
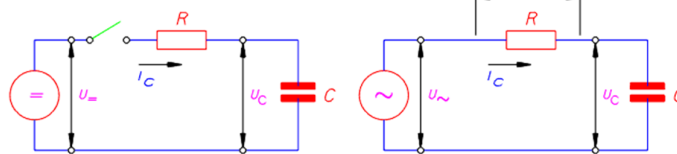

za ~ strujni krug
 $u \Rightarrow i$ trajno uz φ

$$u = i \cdot R + \frac{1}{C} \int i \cdot dt$$

ako je

$$i = \sqrt{2} \cdot I \cdot \sin \omega t$$

$$u = \sqrt{2} \cdot U \cdot \sin(\omega t + \varphi)$$

tada vrijedi

$$U = I \cdot \sqrt{R^2 + X_C^2} = I \cdot Z$$

$$Z = \sqrt{R^2 + X_C^2}$$

$$\underline{Z} = R - jX_C = Z \cdot e^{-j\varphi} = Z \angle \varphi$$

$$\varphi = \operatorname{arctg} \left(-\frac{X_C}{R} \right) = \operatorname{arctg} \left(-\frac{1}{\omega RC} \right) \quad 0 \leq \varphi \leq -\frac{\pi}{2}$$