

Sveučilište u Zagrebu
Rudarsko-geološko-naftni fakultet

GOSPODARENJE PLINOVIMA 1



Predavanje:

UKAPLJENI PRIRODNI PLIN (LNG)

Doc. dr. sc. Daria Karasalihović Sedlar

Zagreb, 2010.



UPP

- Prirodni plin ohlađen na -162°C (temperatura na kojoj je metan u tekućem stanju)
- Odnos tekućine i plina = 1: 600
- Skladišti se i transportira na atmosferskom tlaku i *boiling point* temperaturi
- Bez mirisa i boje



RGNF

UPP

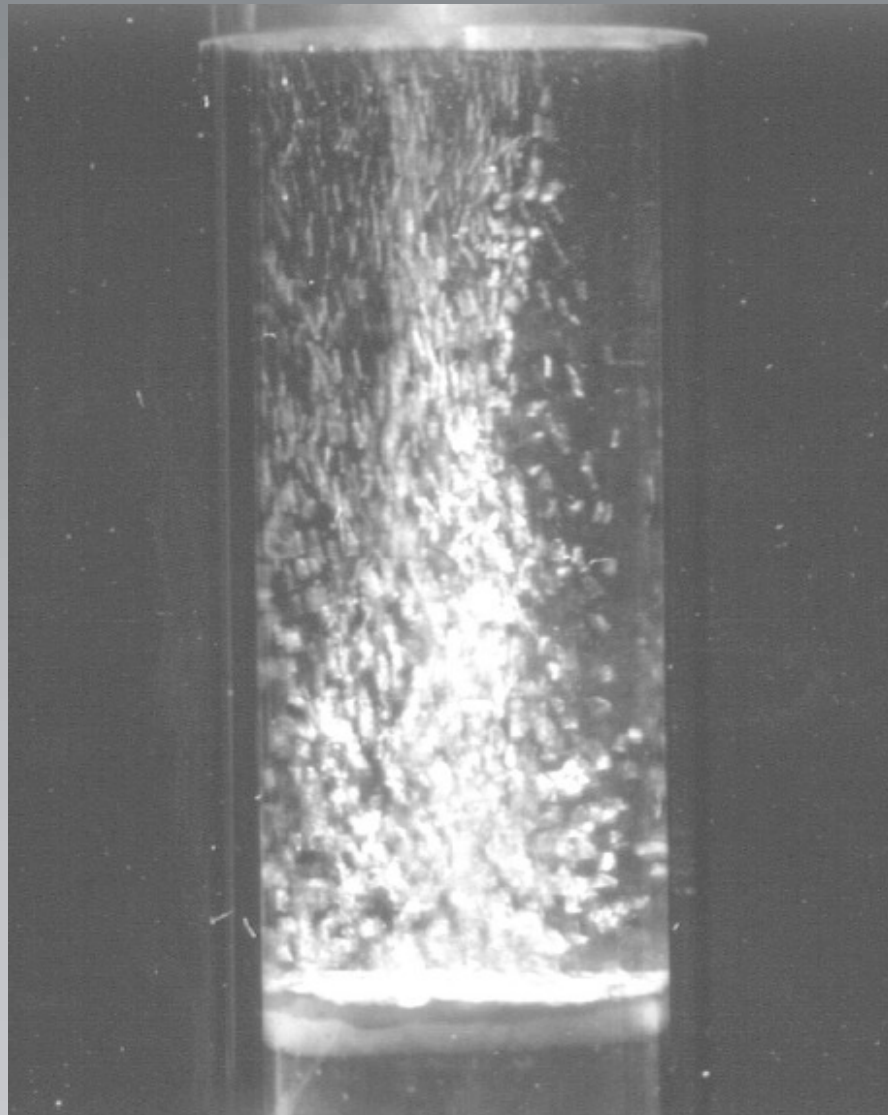



TRGOVINA PLINOM U SVIJETU

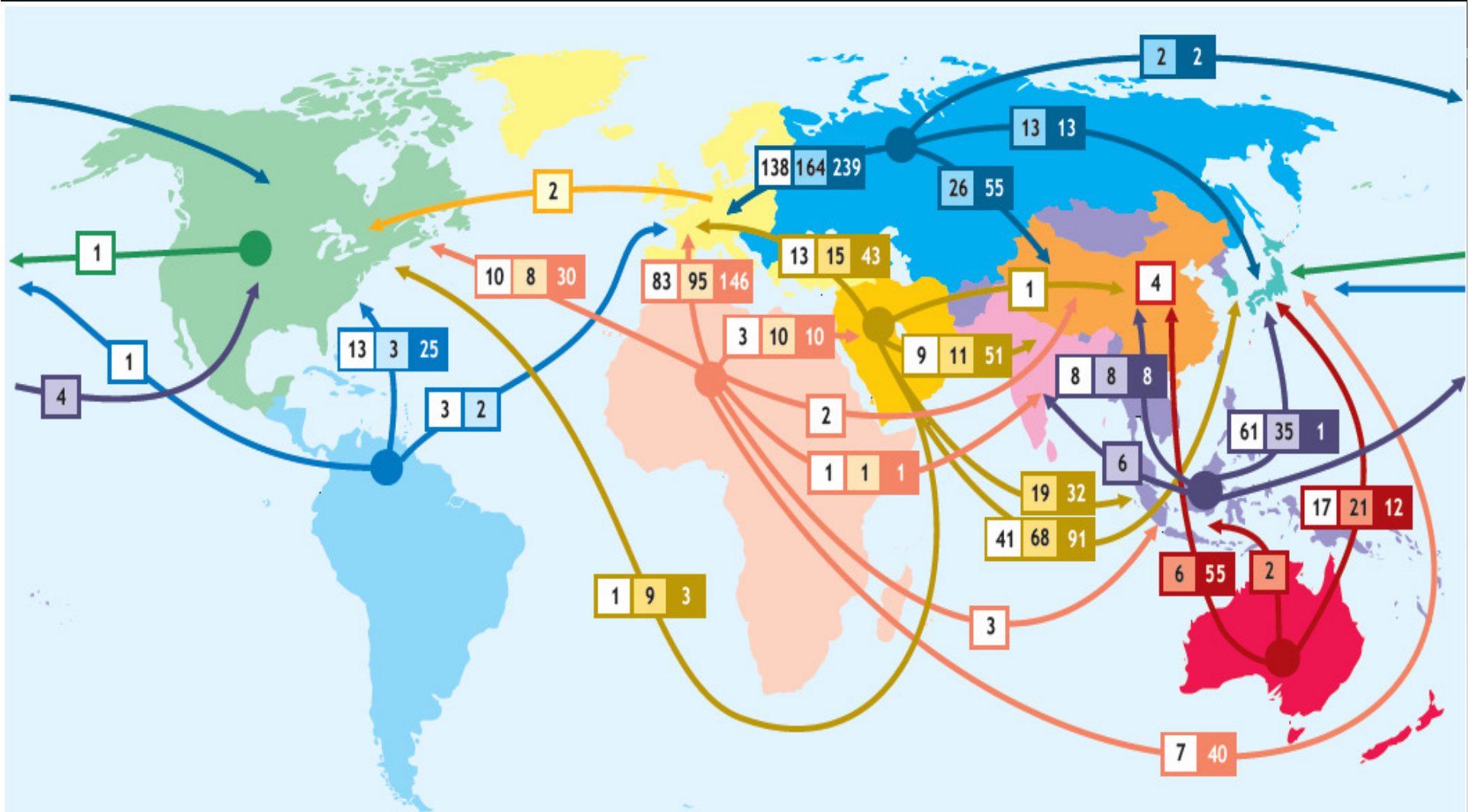

Source: WEO 2009

1 2007 2 2015 3 2030

OECD North America

Latin America

OECD Europe

Eastern Europe/Eurasia

Africa

Middle East

India

OECD Asia

China

Other Asia

OECD Oceania



SVJETSKA OPSKRBA PLINOM

RGNF

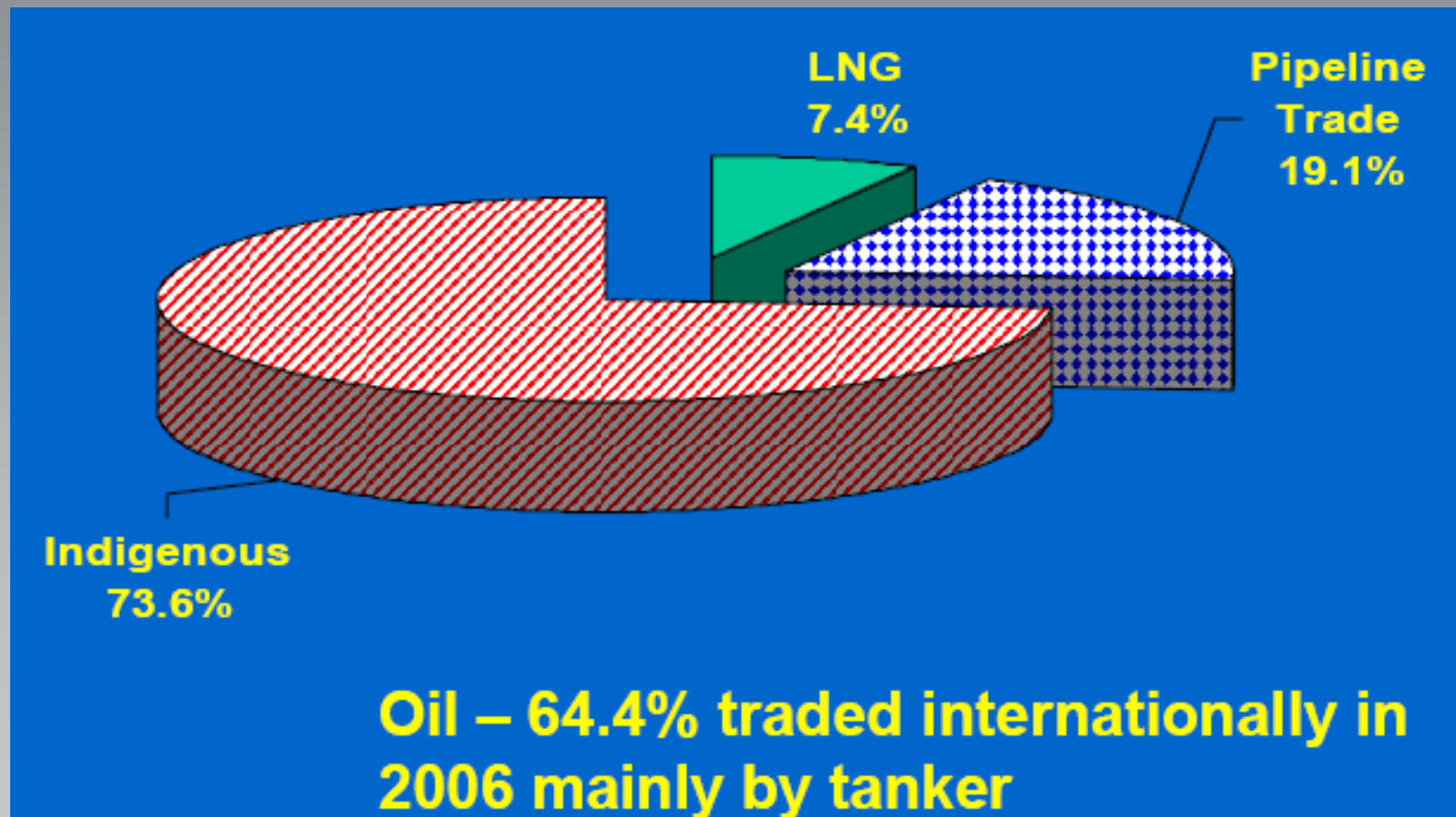



OPSKRBA EUROPE PLINOM

RGNF

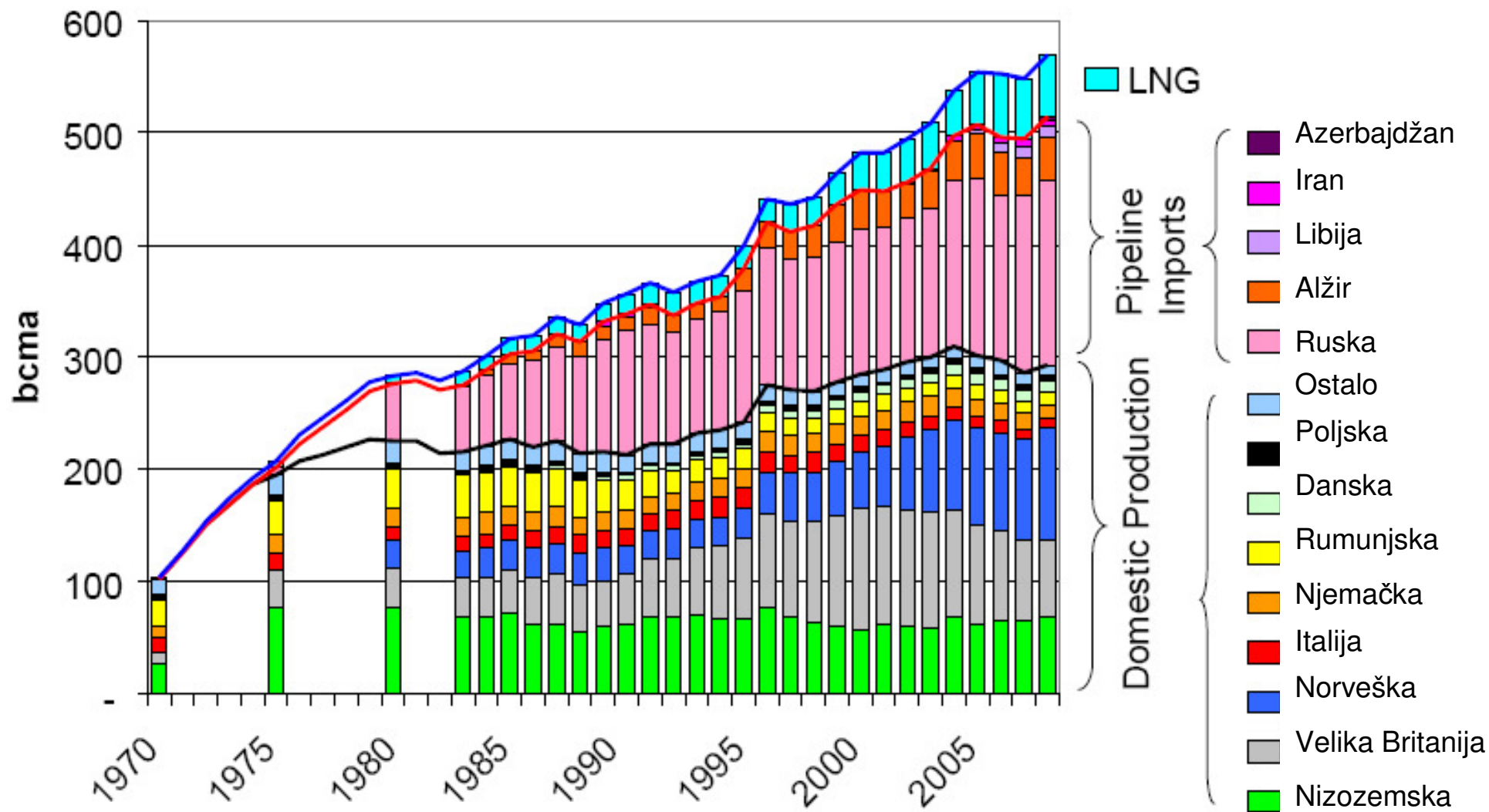



UVOZ PLINA PLINOVODIMA I UPP UVOZNI PRAVCI

(bcma)

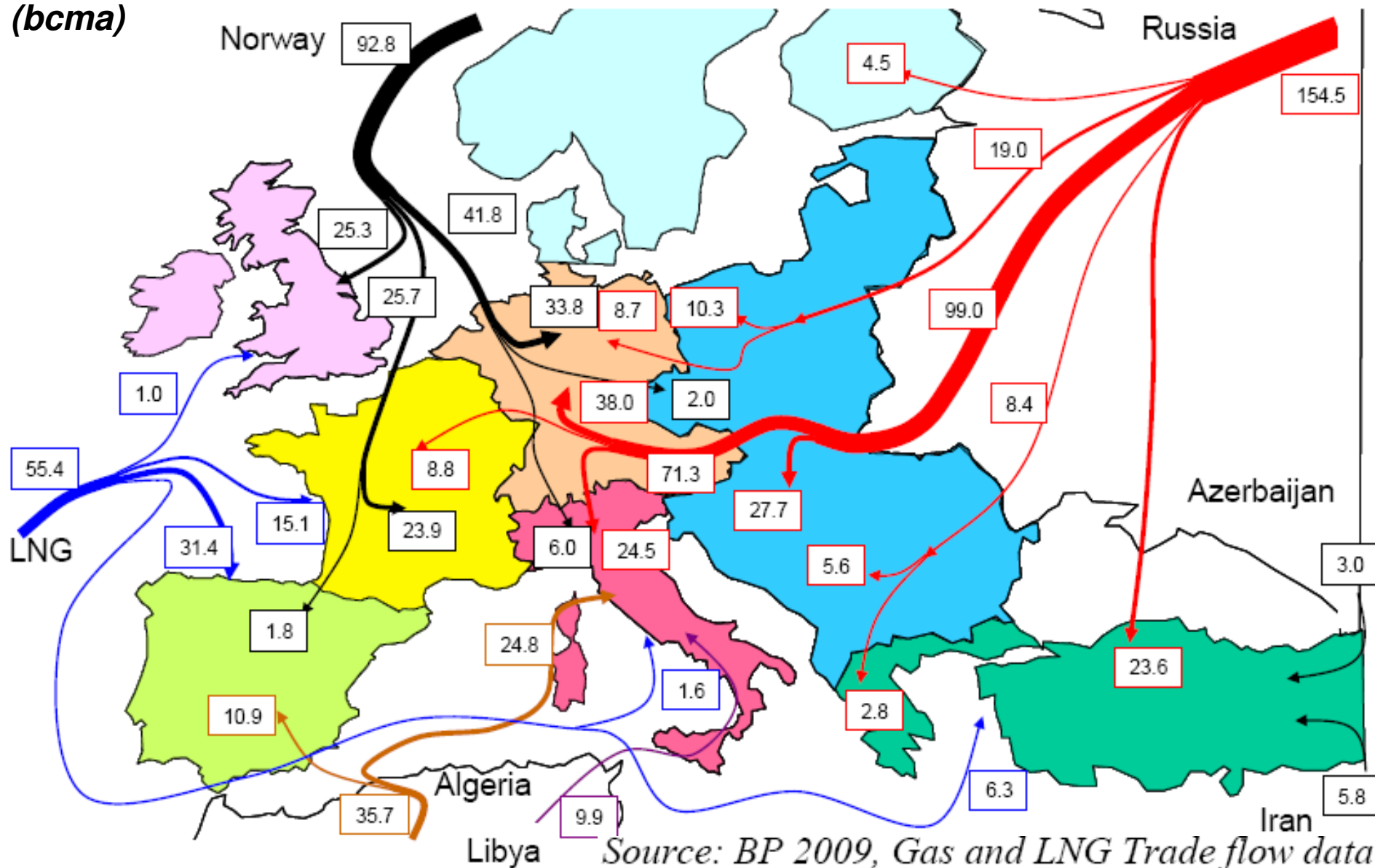



UDIO UPP U OPSKRBI PLINOM

RGNF

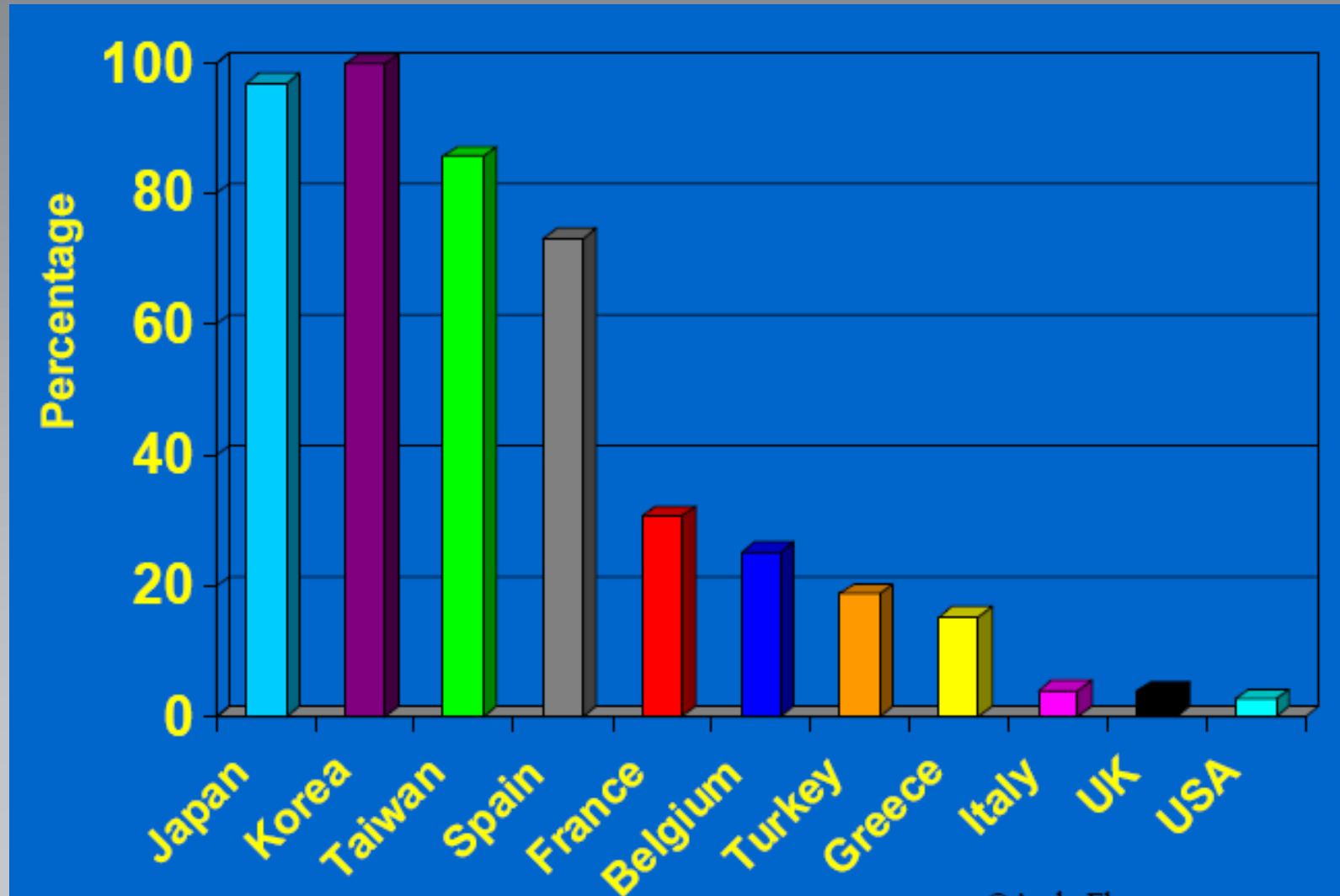



TROŠKOVI TRANSPORTA ENERGENATA OD BUŠOTINE DO TRŽIŠTA

RGNF

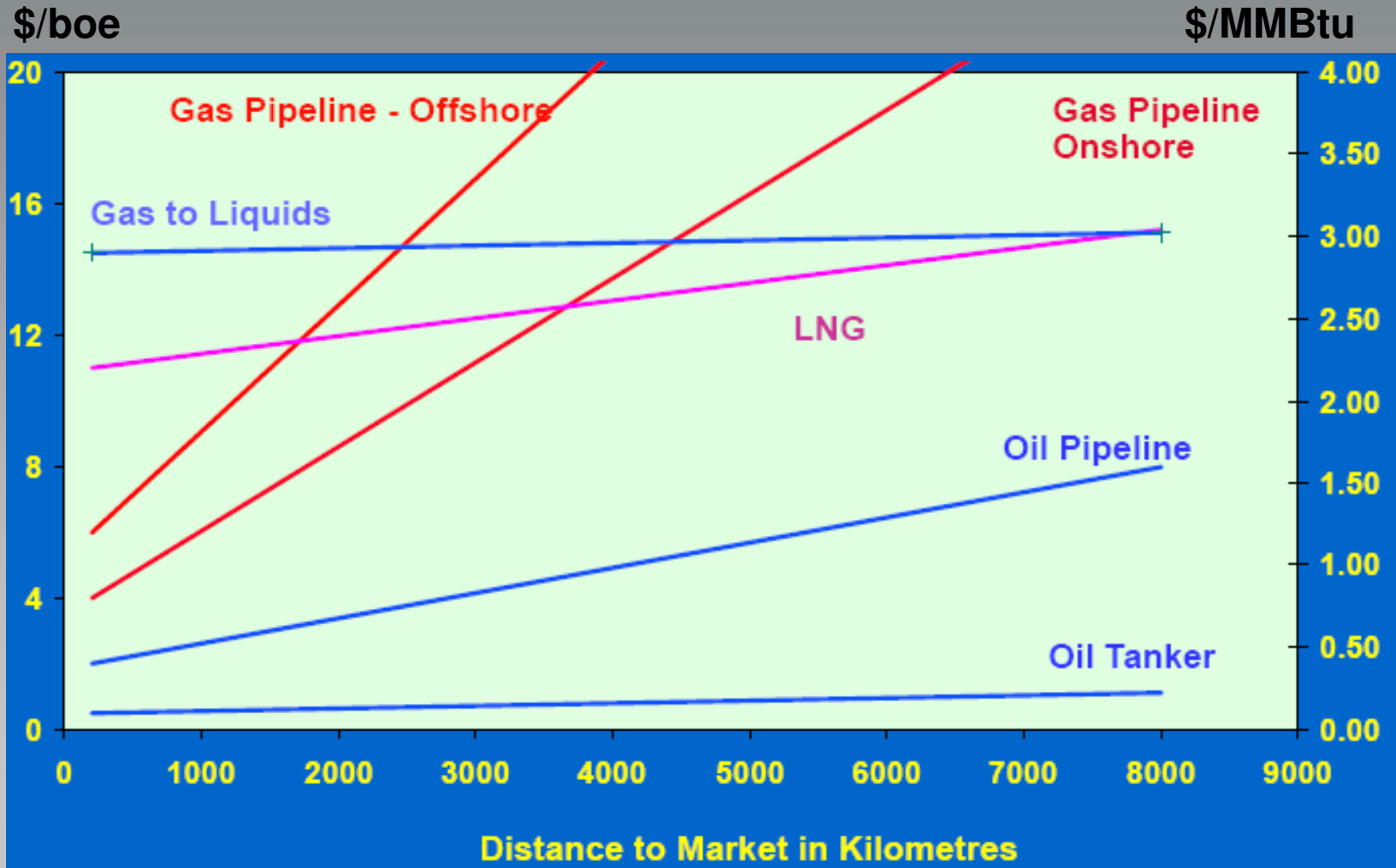



RGNF

UPP

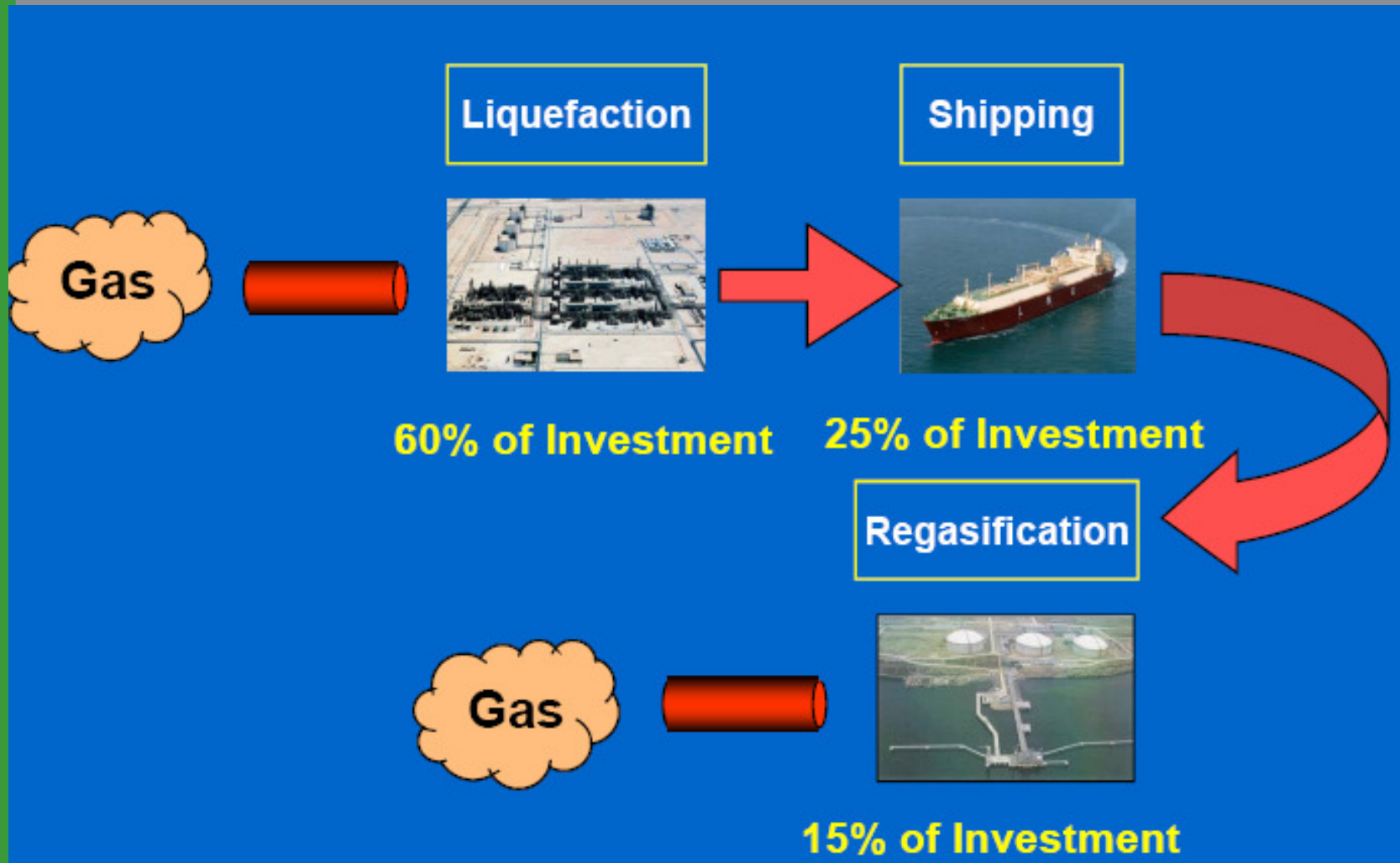



POVIJEST KORIŠTENJA LNG

RGNF

- Početak 20. st.- ukapljivanje plina za proizvodnju He
- 1938. g.- prva tvornica za proizvodnju UPP- a, Zapadna Virginia
- 1944. g.- Prva velika UPP nesreća- Cleveland (Ohio), 128 poginulih
- 1959. g.- pokusna vožnja metanjera *Methane Pioneer* od SAD do UK



UVOZNICI UPP-a 1964.- 2007.

RGNF

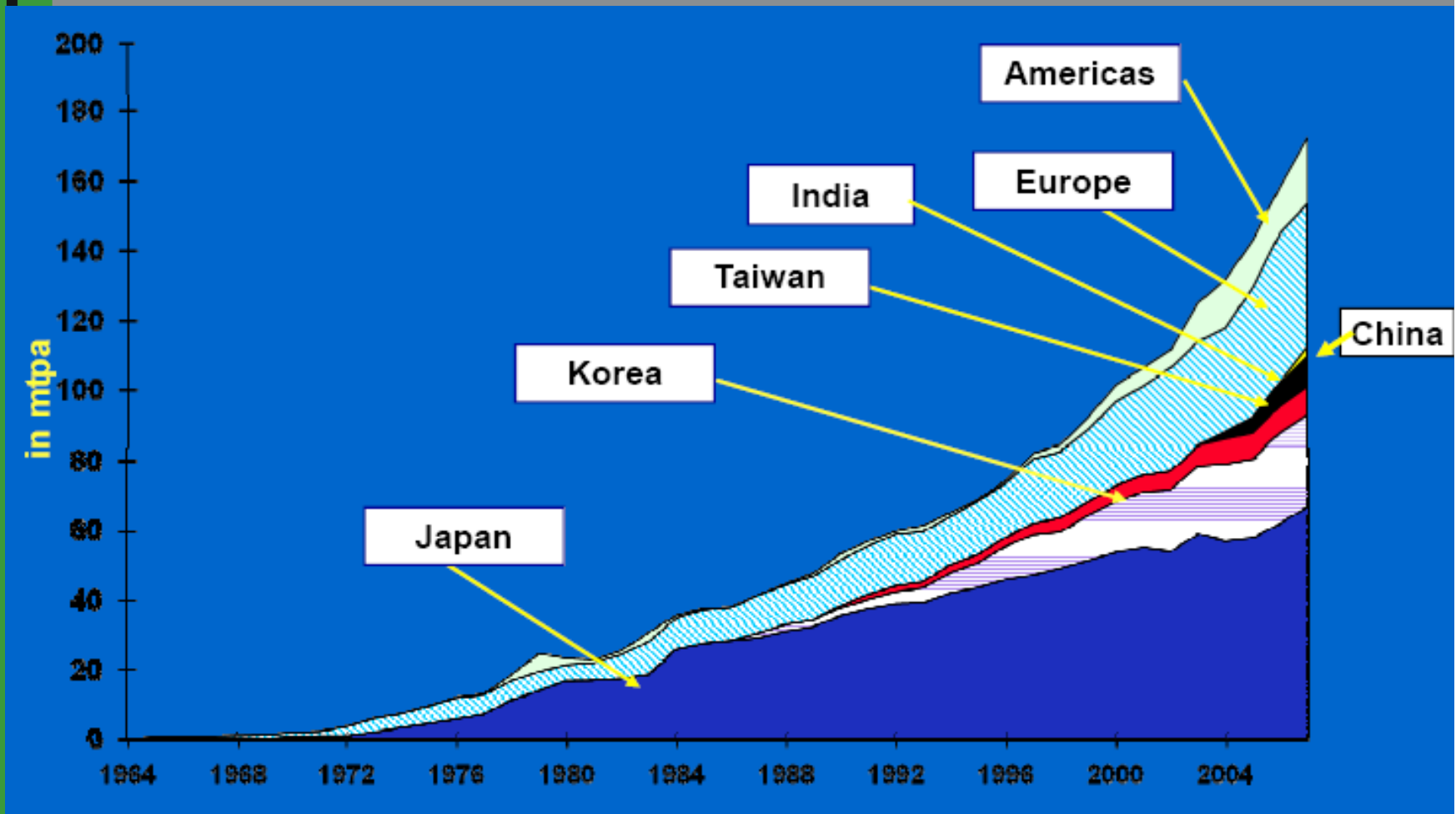



UVOZ UPP-a 2008.

RGNF

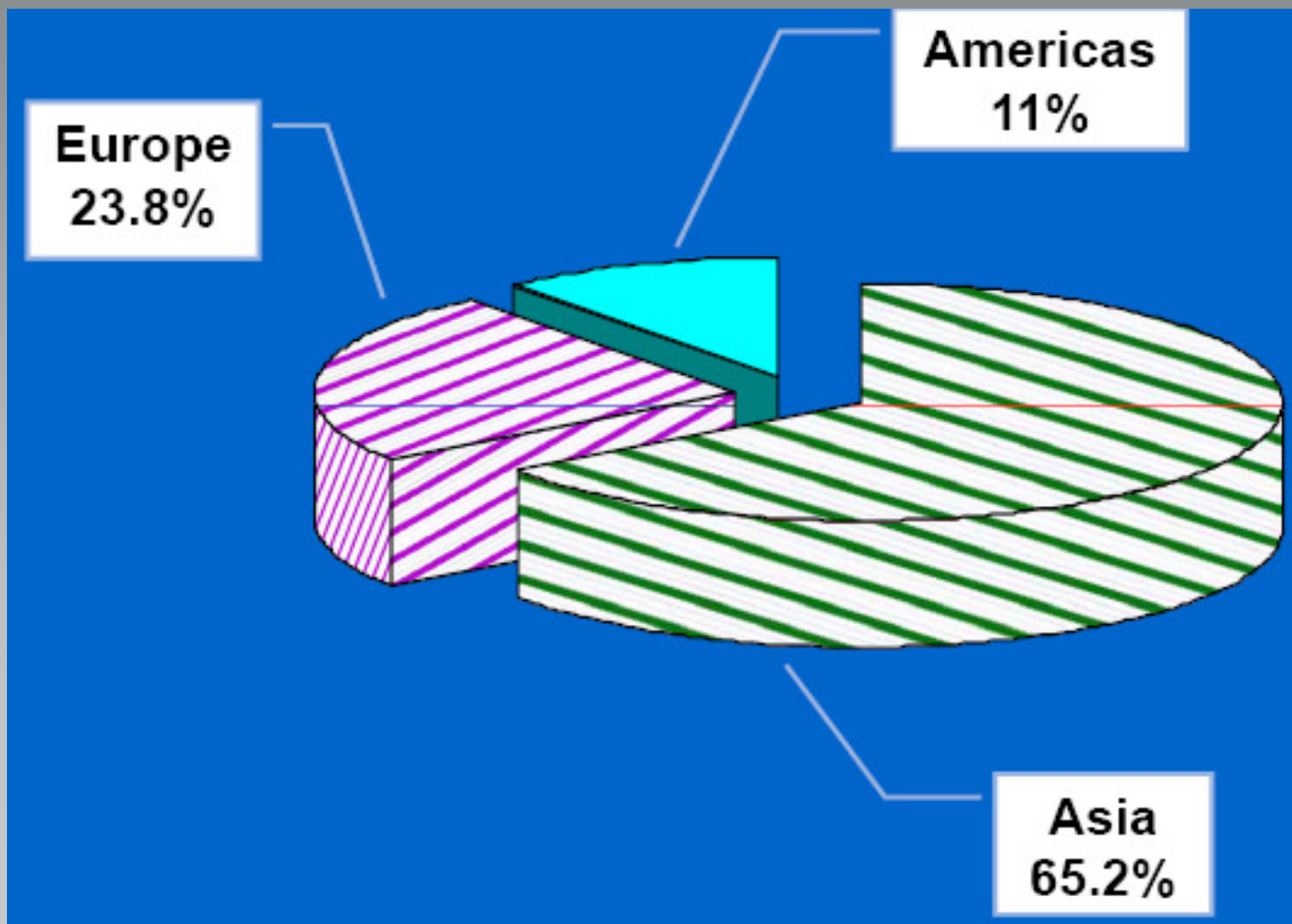



UVOZ UPP-a do 2009. g.

RGNF

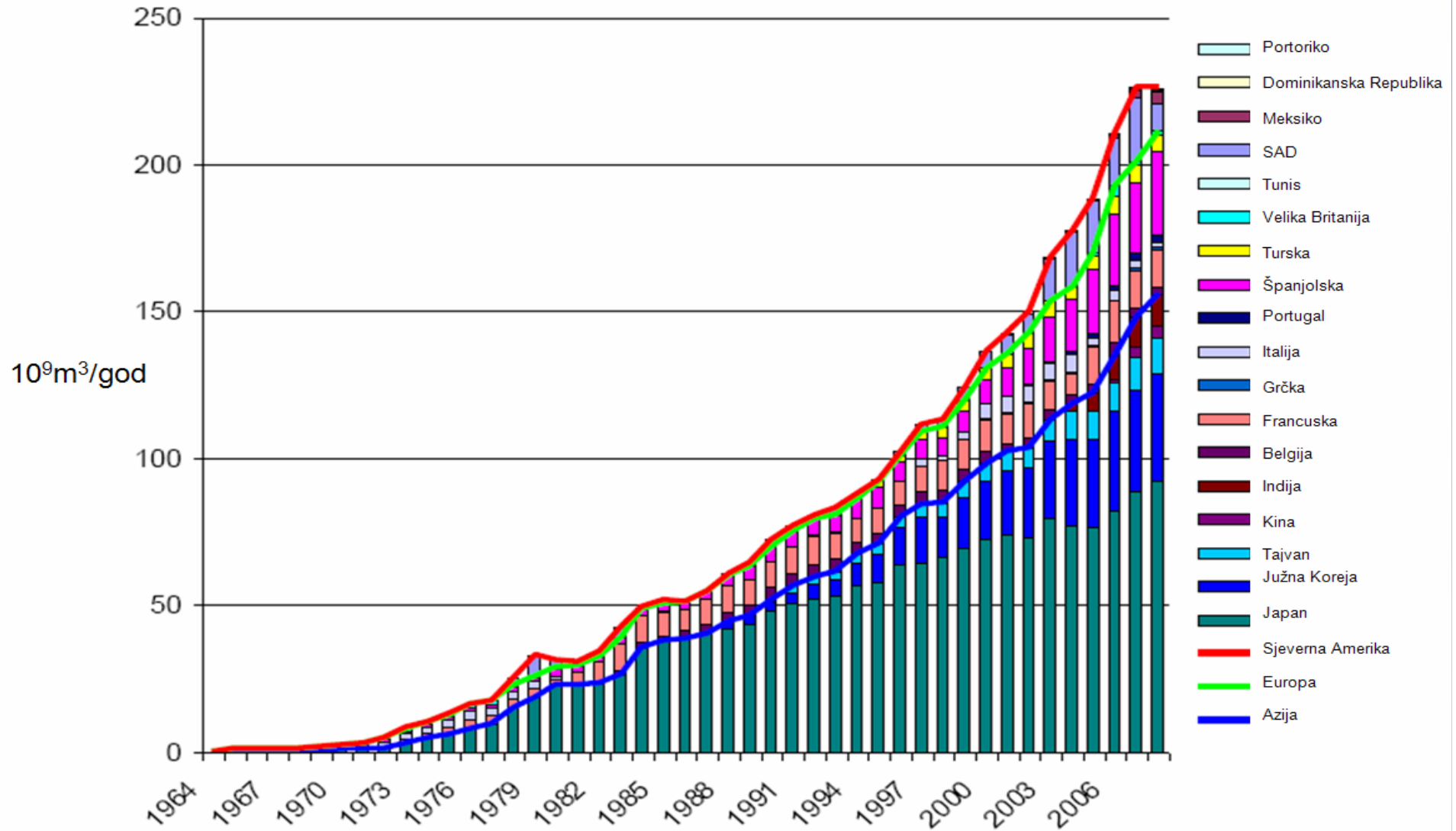



AZIJSKO TRŽIŠTE ZA UVOZ UPP-a 2009. g.

RGNF

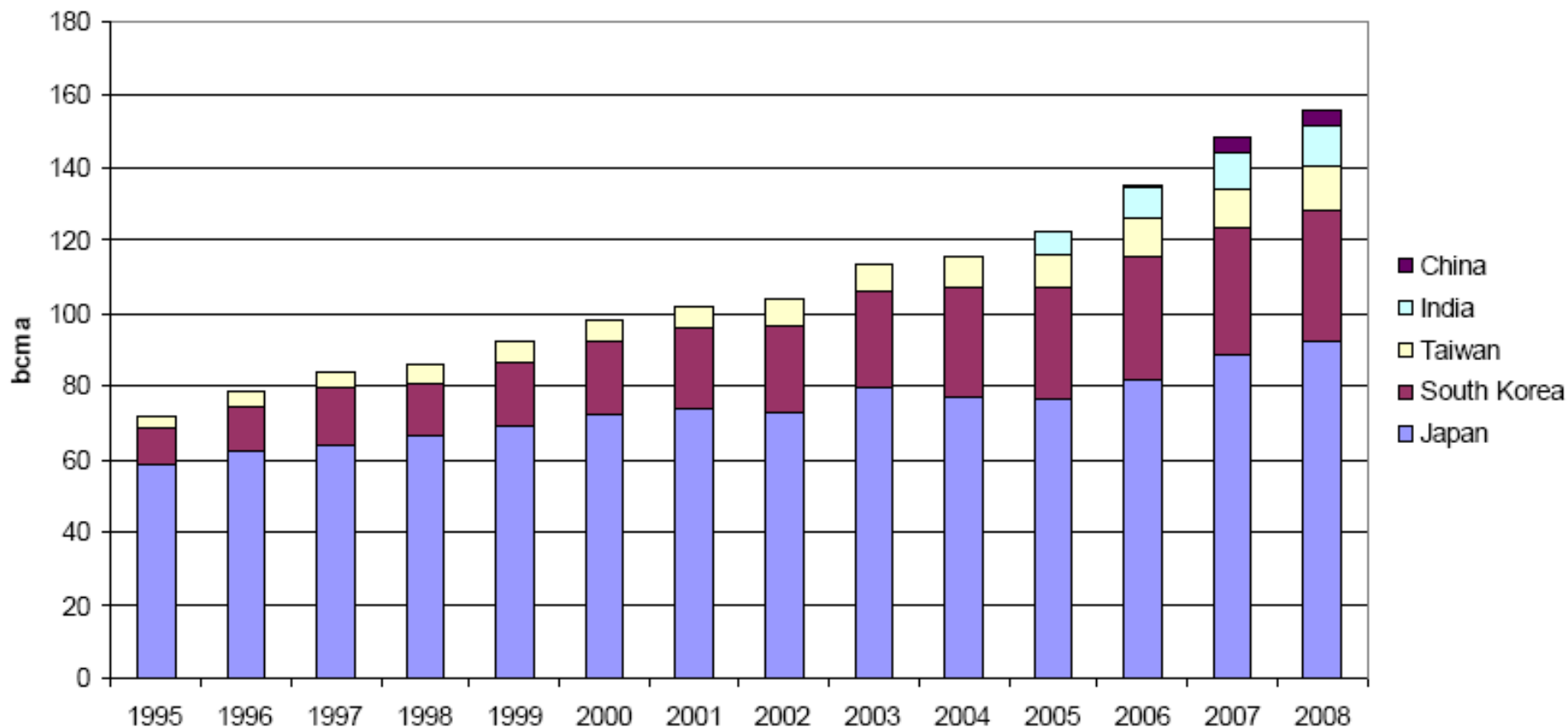

Source: BP 2009, (LNG Gas Trade Sheet)



IZVOZNICI UPP-a 1964.- 2007.

RGNF

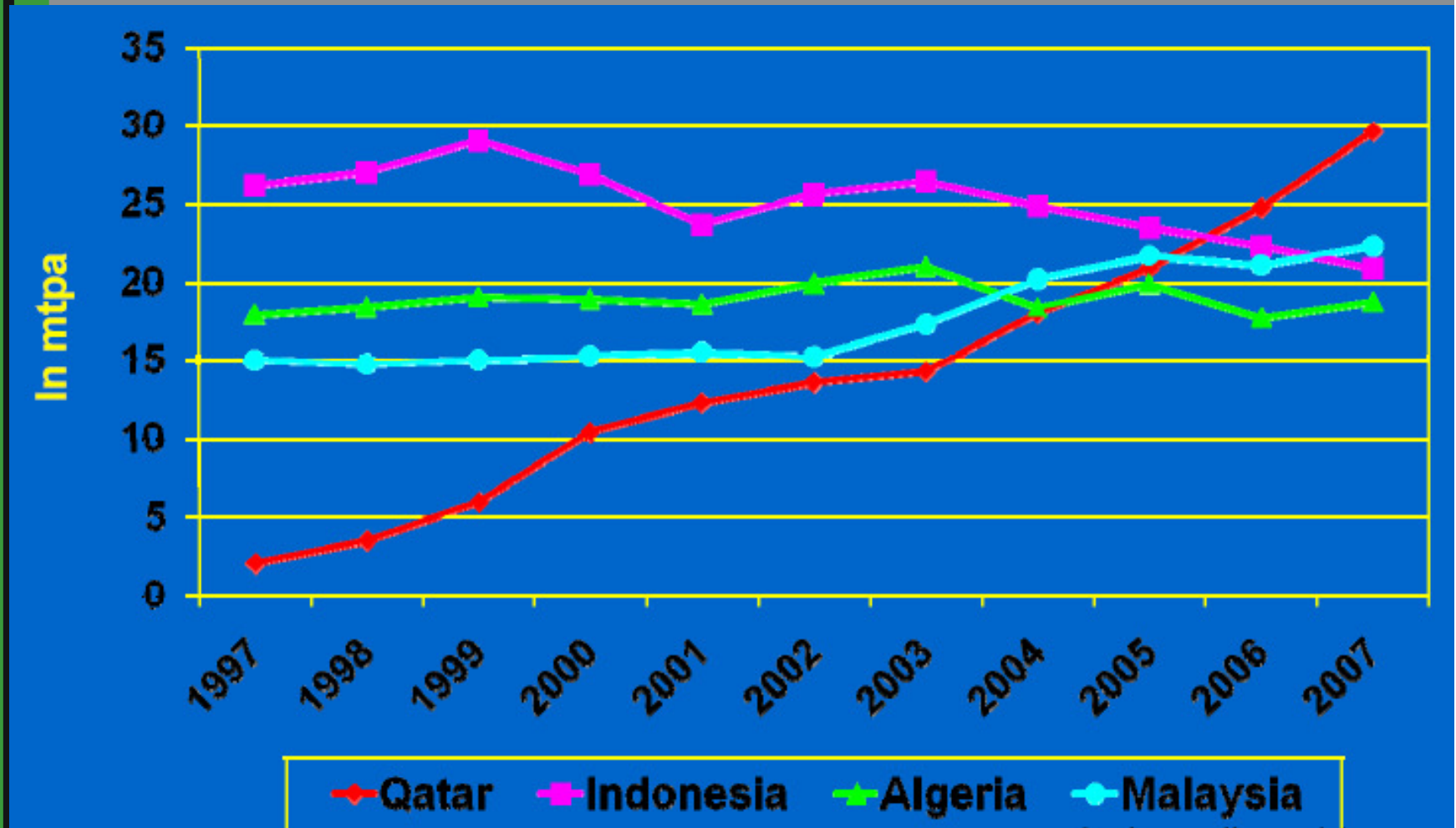



RGNF

REGIONALNA PROIZVODNJA UPP-a 1990.- 2008.

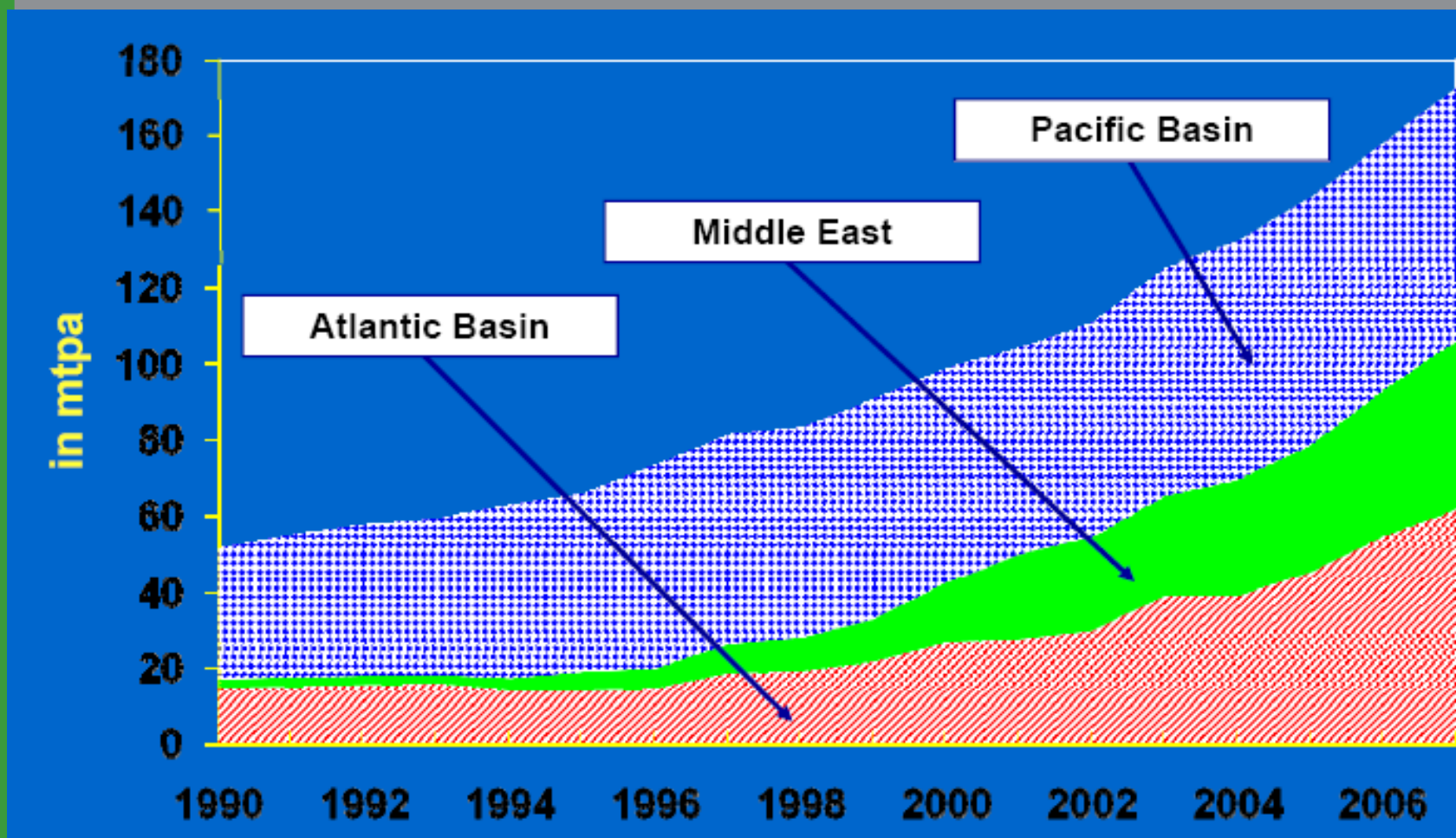



KAPACITETI POSTROJENJA ZA UKAPLJIVANJE

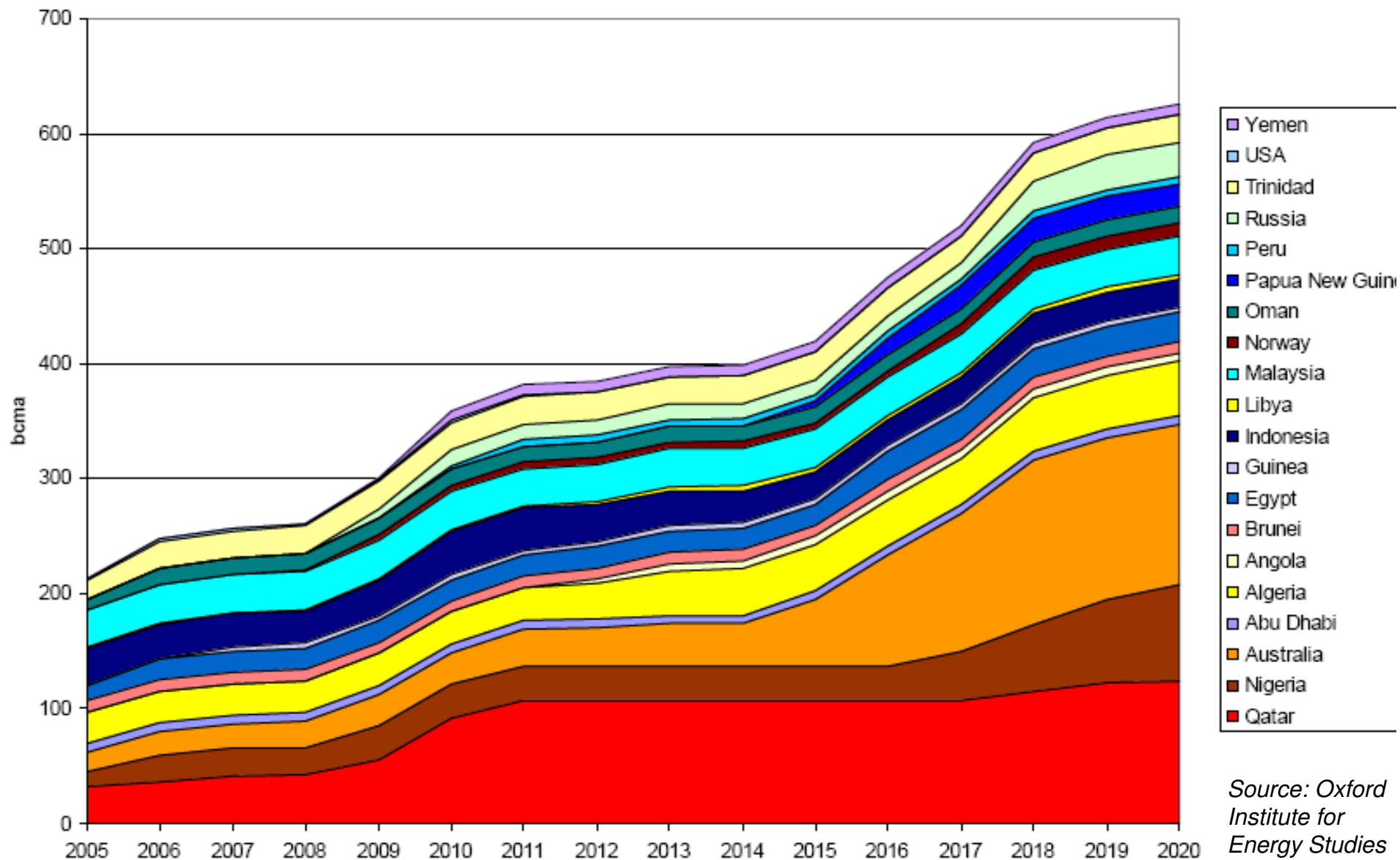

Source: Oxford
Institute for
Energy Studies



RGNF

POSTOJEĆI KAPACITETI ZA UKAPLJIVANJE U 10⁶t/god (2008.)

Asia Pacific		Middle East		Atlantic Basin		Total
<u>Operating</u>						
Alaska (Kenai)	1.3	Abu Dhabi	5.7	Algeria (Arzew)		
Brunei	7.2	Qatargas	10.0	GL1Z, GL2Z, GL4Z	17.3	
Indonesia (Bontang)	22.6	Qatar (RasGas)	20.7	Algeria (Skikda)	2.9	
Indonesia (Arun)	3.5	Oman	11.0	Libya (Marsa El Brega)	0.6	199.8
Malaysia Satu	8.1			Trinidad&Tobago	15.7	
Malaysia Dua	7.8			Nigeria	22.3	
Malaysia Tiga	7.4			Egypt (Damietta)	5.0	
Australia (NWS)	12.2			Egypt (Idku) Trains 1&2	7.2	
Australia (Darwin)	3.6			Equatorial Guinea	3.6	
				Norway (Snohvit)	4.1	
<u>Under Construction</u>						
Russia (Sakhalin)	9.6	Rasgas III	15.6	Angola LNG	5.2	
Indonesia (Tangguh)	7.6	Qatargas II	15.6	Algeria (Skikda Rebuild)	4.5	95.0
Australia NWS Train 5	4.4	Qatargas III	7.8			
Malaysia Dua Debottle	1.5	Qatargas IV	7.8			
Peru LNG	4.4	Yemen LNG	6.7			
Australia (Pluto)	4.3					



KAPACITETI ZA UKAPLJIVANJE – FID

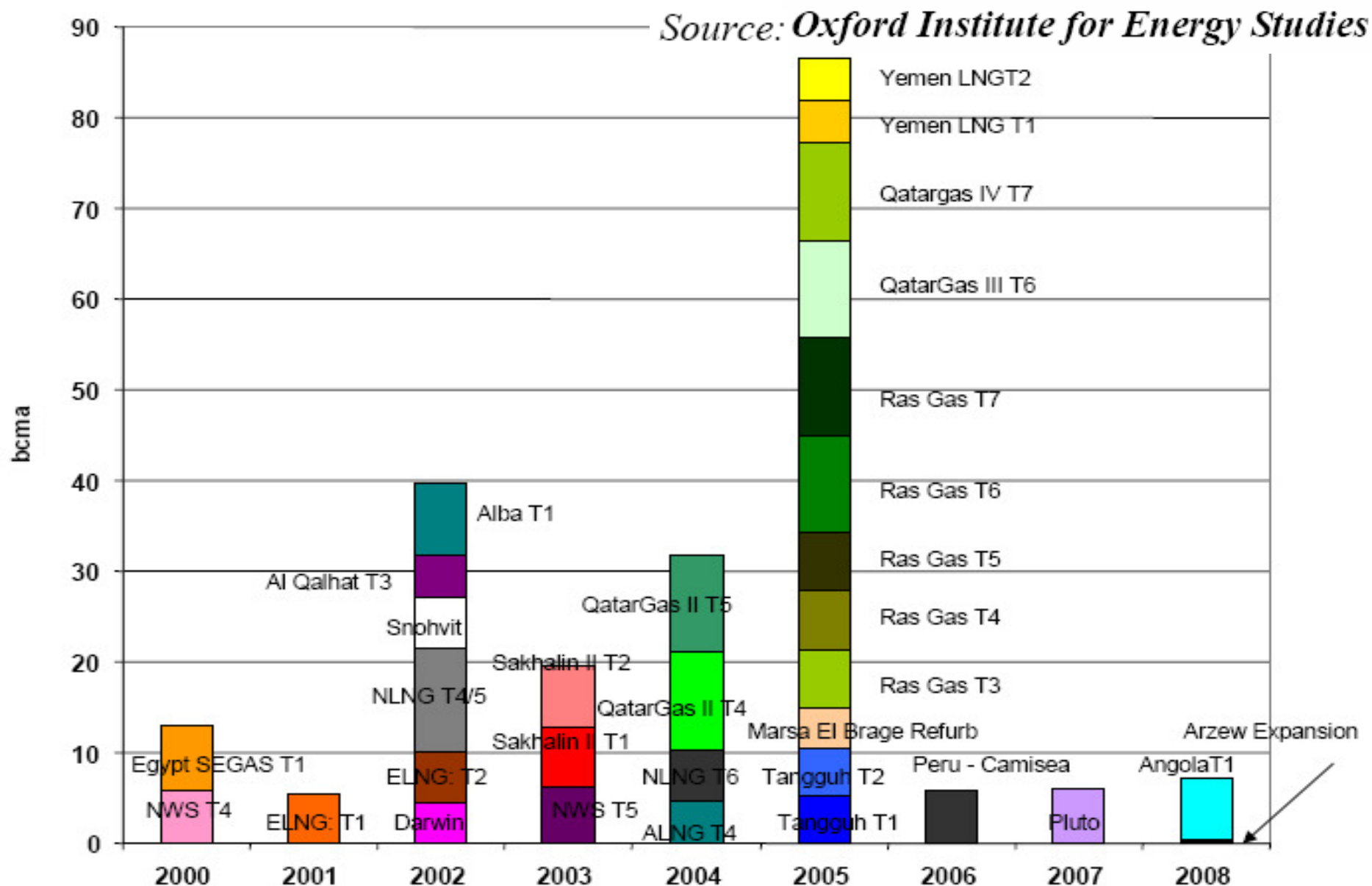



PORAST PONUDE UPP-a

RGNF

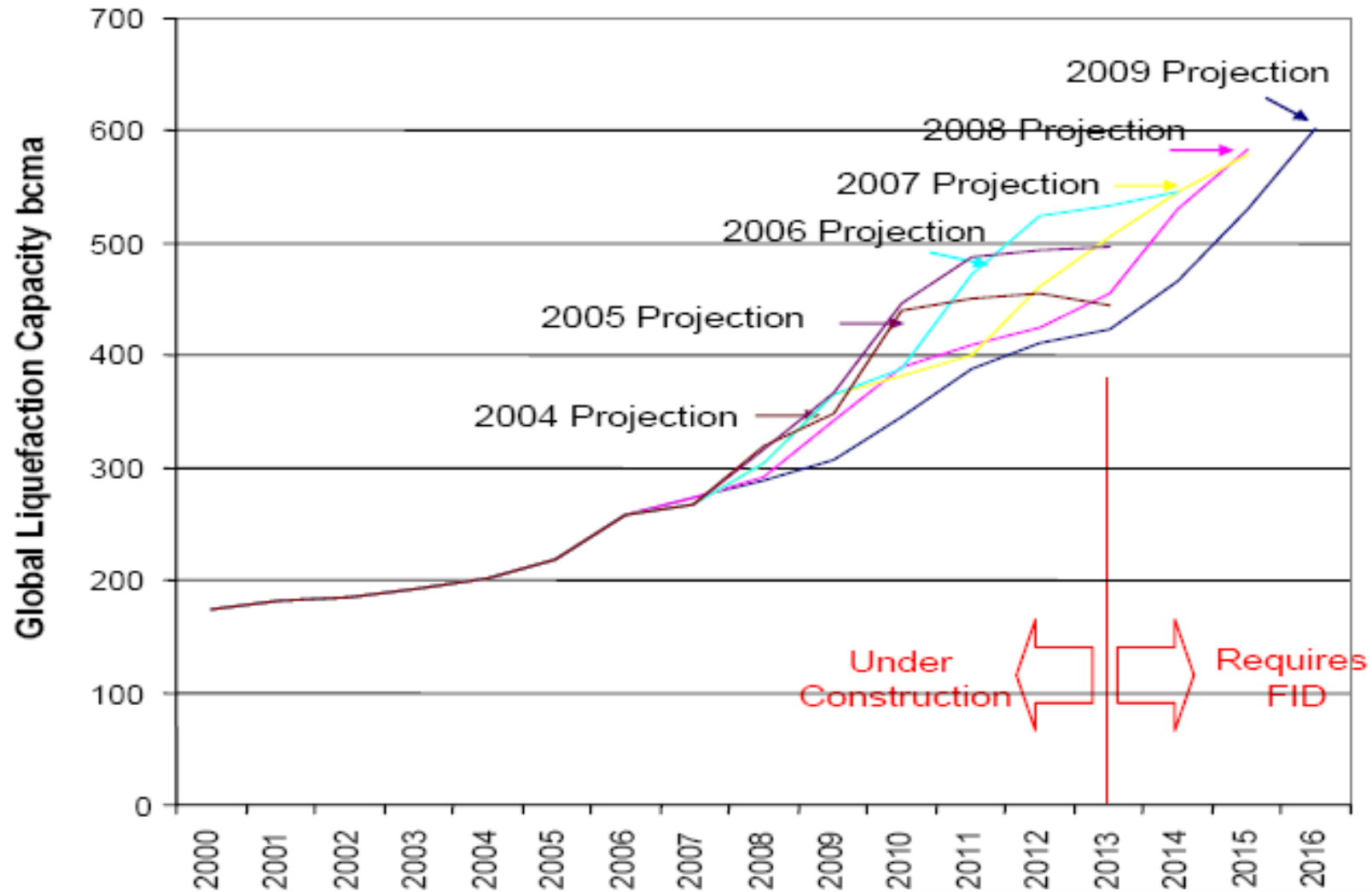

Source: Oxford Institute for Energy Studies



TERMINALI ZA UKAPLJIVANJE (2008.)

RGNF





PLANIRANI KAPACITETI ZA UKAPLJIVANJE U 10⁶t/god (2008.)

RGNF

Asia Pacific		Middle East		Atlantic Basin		Total
Indonesia (Tangguh) T3	3.8	Iran (Pars LNG)	10.0	Libya Revamp	2.6	
Indonesia (Padang)	2.0	Iran (Persian LNG)	16.0	Libya (Ras Lanuf)	4.0	
Indonesia (Senkang)	2.0	Iran (Iran LNG)	10.0	Russia (Shtokman)	15.0	
Australia (Pluto) T2/3	8.6	Iran (Qeshm LNG)	3.5	Egypt (Idku) T3	3.6	
Australia (Ichthys)	6.0			Egypt (Damietta) T2	5.0	
Australia (Gorgon)	15.0			Venezuela	9.4	
Australia (Browse)	10.0			Algeria (Gassi Touil)	4.0	237.5
Australia (Sunrise)	5.0			Nigeria (Brass)	10.0	
Australia (Pilbara)	6.0			Nigeria LNG T7	8.5	
Australia (Gladstone)	4.0			Nigeria LNG T8	8.5	
Australia (Gladstone)	1.3			Nigeria OK LNG	22.0	
Russia Sakhalin T3	4.8			Equatorial Guinea T2	4.4	
PNG (Elk)	9.0			Trinidad & Tobago Debot.	3.0	
PNG (Hides)	6.3			Trinidad & Tobago TX	5.2	
PNG (Elk)	9.0					



KAPACITETI ZA UKAPLJIVANJE U 10⁶t/god (2008.)

RGNF

Region	Operating	Under Construction	Planned	Total
Pacific Basin	73.7	31.8	92.8	198.3
Middle East	47.4	53.5	39.5	140.4
Atlantic Basin	78.7	9.7	105.2	193.6
TOTAL	199.8	95.0	237.5	532.3

Expected Production in 2008: 184mt



TERMINALI UPLINJAVANJE- UVOZNICI UPP-a

RGNF





TERMINALI UPLINJAVANJE 2008.

RGNF

Asia Operating

Japan	27
Korea	4
Taiwan	1
India	2
China	1

Under Construction

India	1
China	3
Taiwan	1

Planned

Japan	3+
Korea	1
China	10+
India	4+
Thailand	1
Singapore	1
Philippines	2
New Zealand	1
Pakistan	1
Hong Kong	1

Europe

France	2
Spain	6
Italy	1
Turkey	2
Greece	1
Belgium	1
Portugal	1
UK	2

France	1
Italy	1
UK	2
Netherlands	1

UK	4
Italy	8+
Spain	3
Cyprus	1
Netherlands	3
Poland	1
Germany	3
Sweden	1
Romania	1
Croatia	1
France	4
Ireland	1

Americas

USA	6
Puerto Rico	1
Dominican Republic	1
Mexico	1

Mexico	1
Canada	1
Chile	2
USA	5
Brazil	2

USA	30+
Bahamas	1
Mexico	5
Canada	6
Caribbean	3
Honduras	1



UDIO UPP- a U SVJETSKOM UVOZU (1964.- 2007.)

RGNF

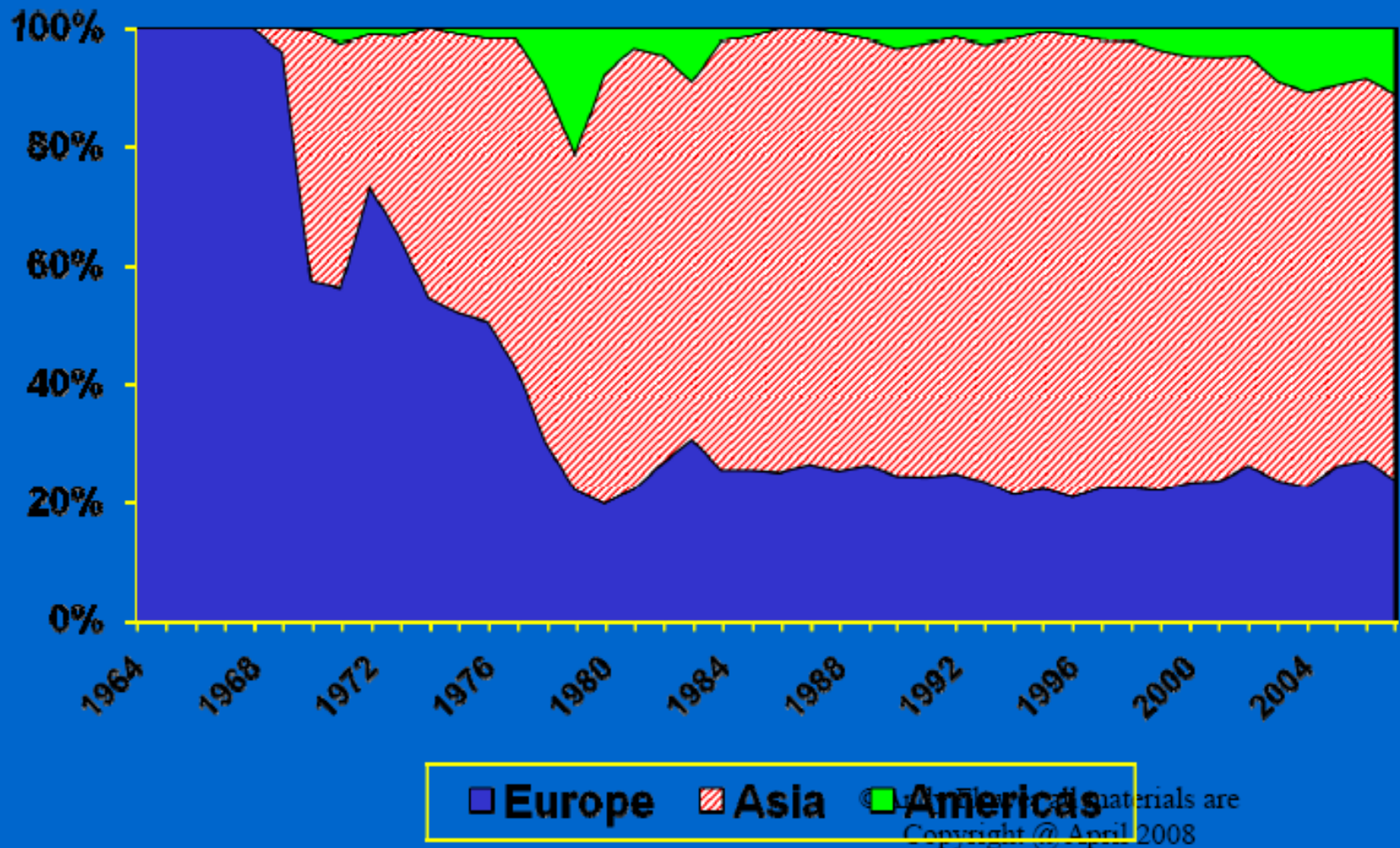



KAPACITETI ZA UPLINJAVANJE

RGNF

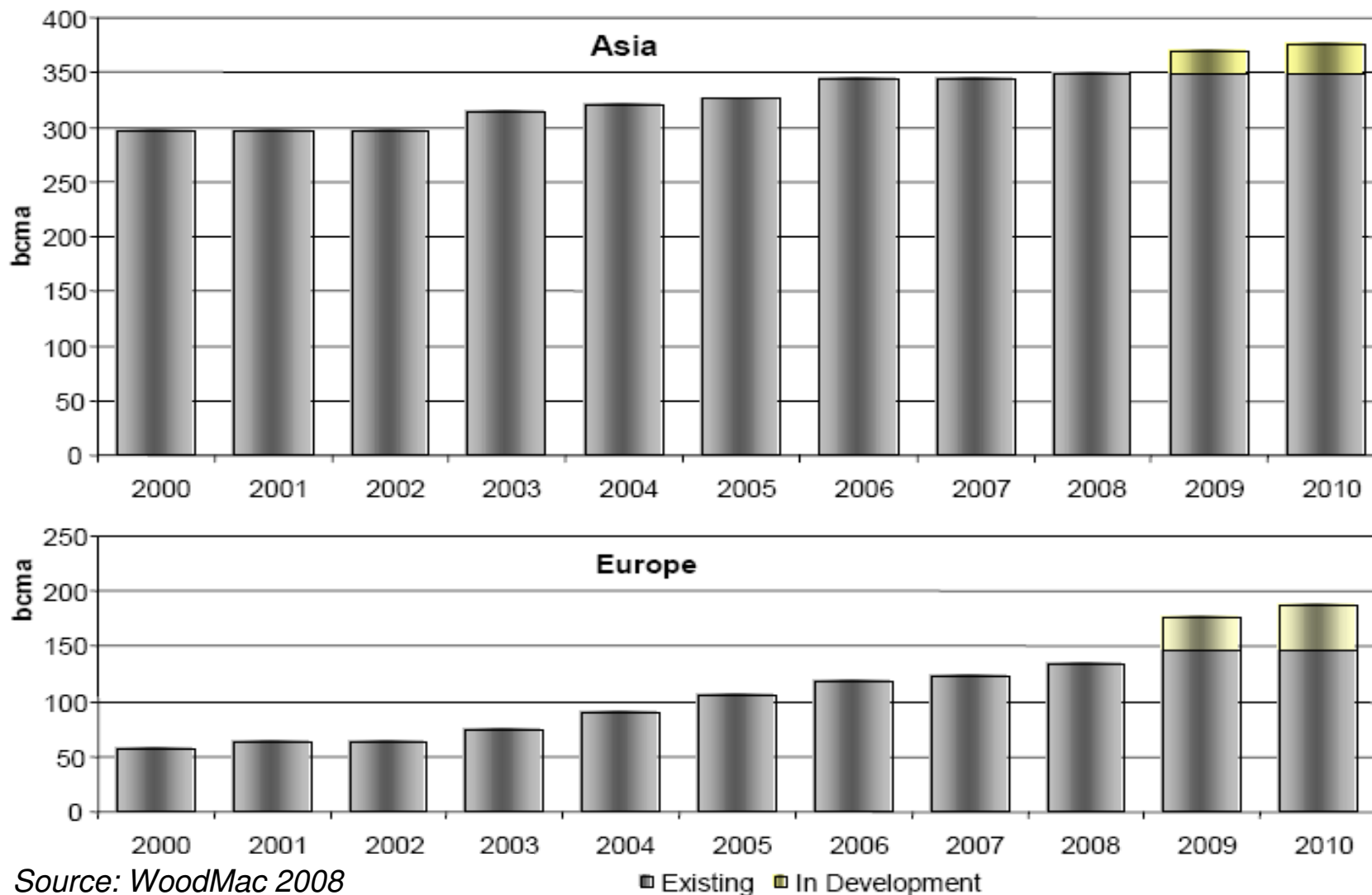



KAPACITETI ZA UPLINJAVANJE

RGNF

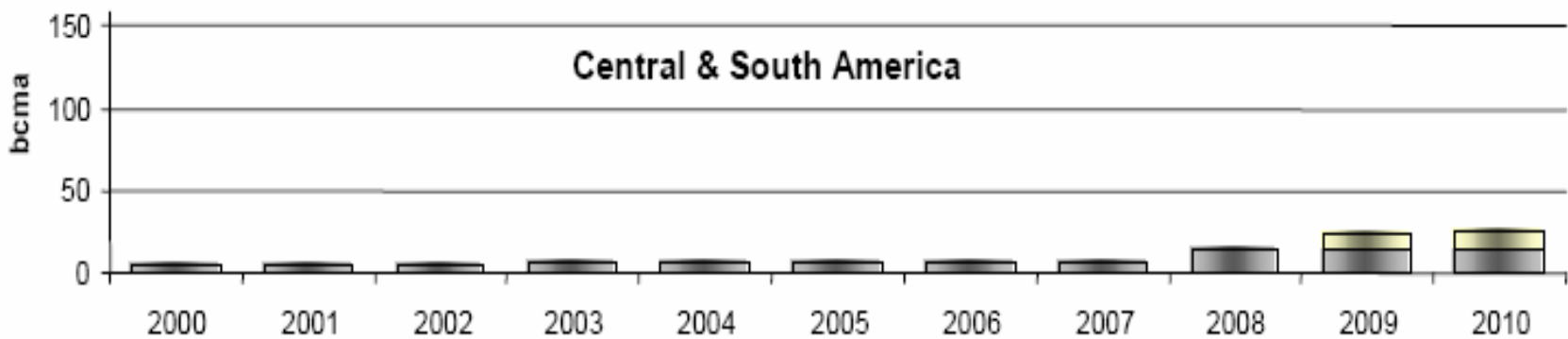
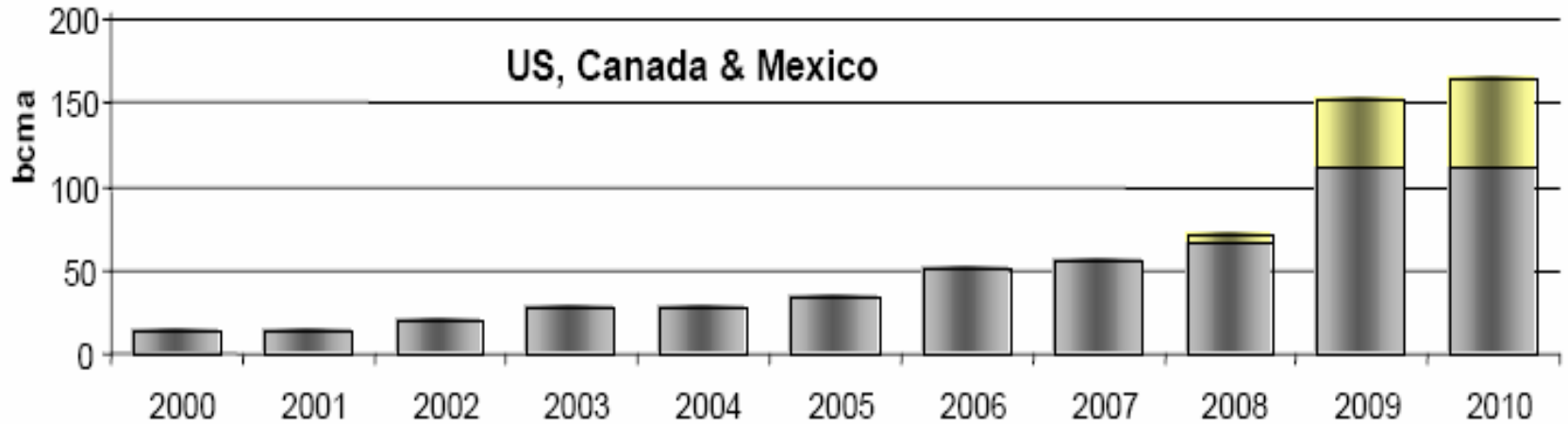

Source: WoodMac 2008

Existing In Development



OPSKRBA EUROPE PLINOM

RGNF

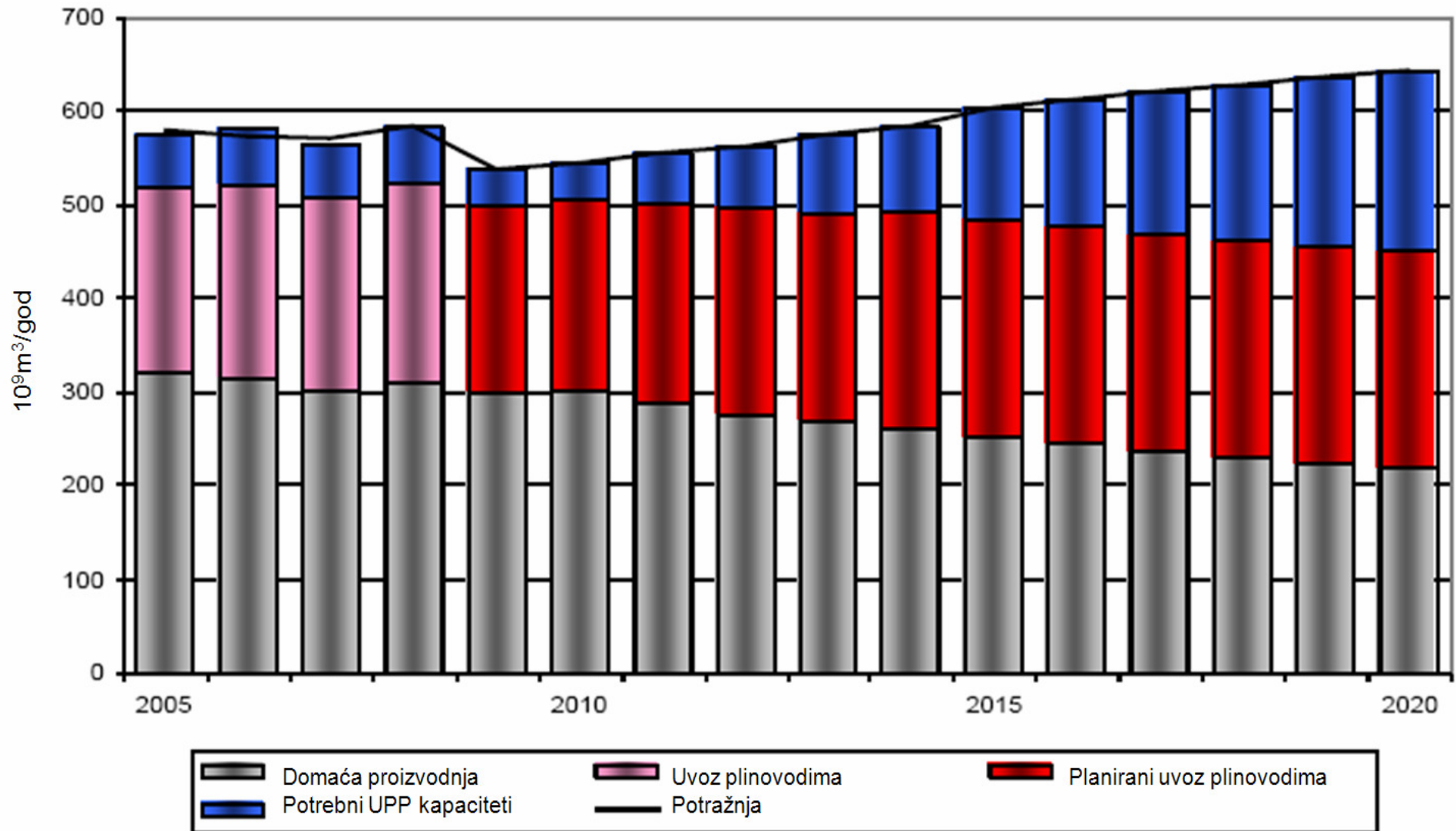



OPSKRBA EUROPE PLINOM

RGNF

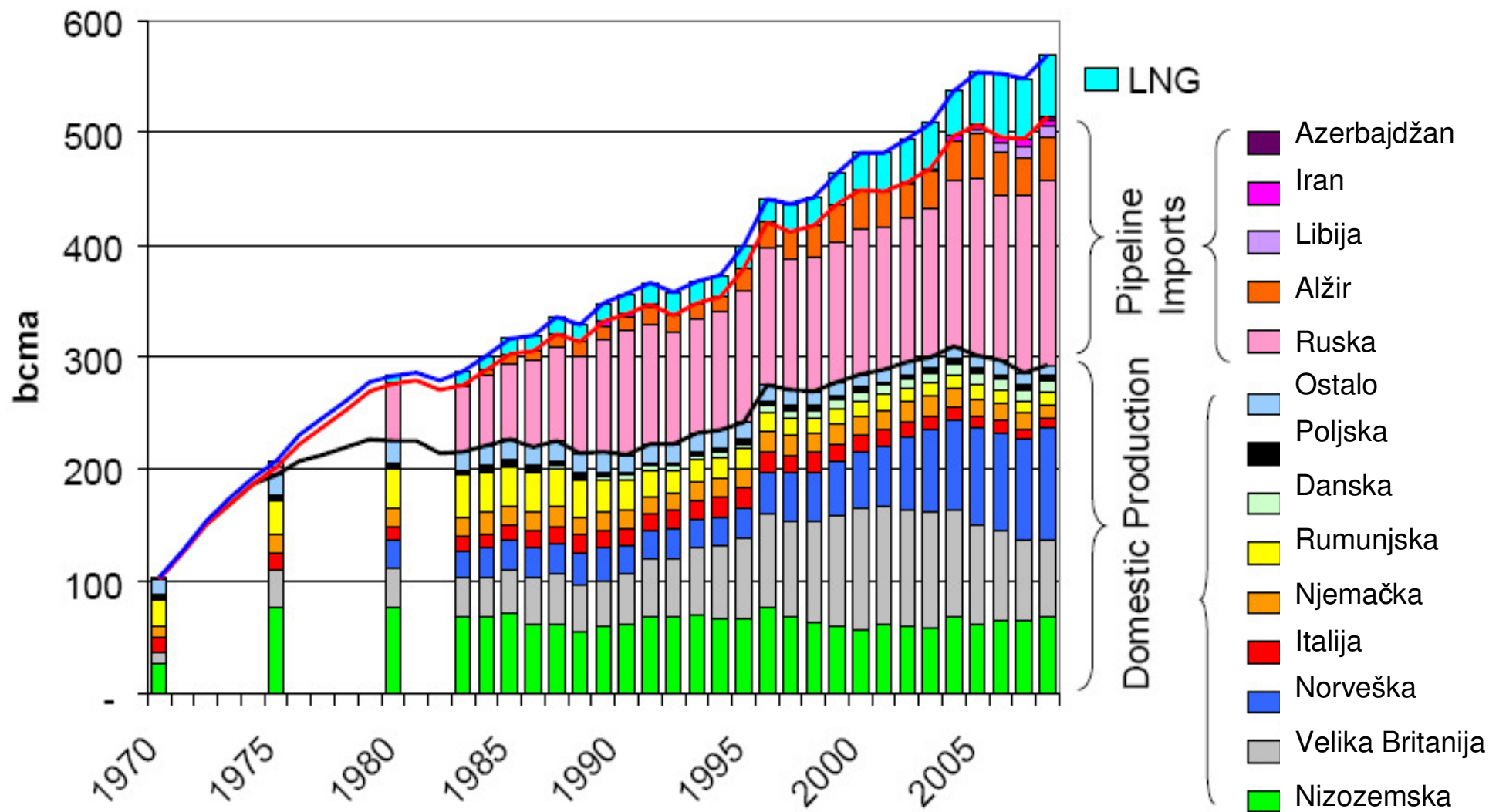



UVOZ PLINA PLINOVODIMA I UPP UVOZNI PRAVCI

(bcma)

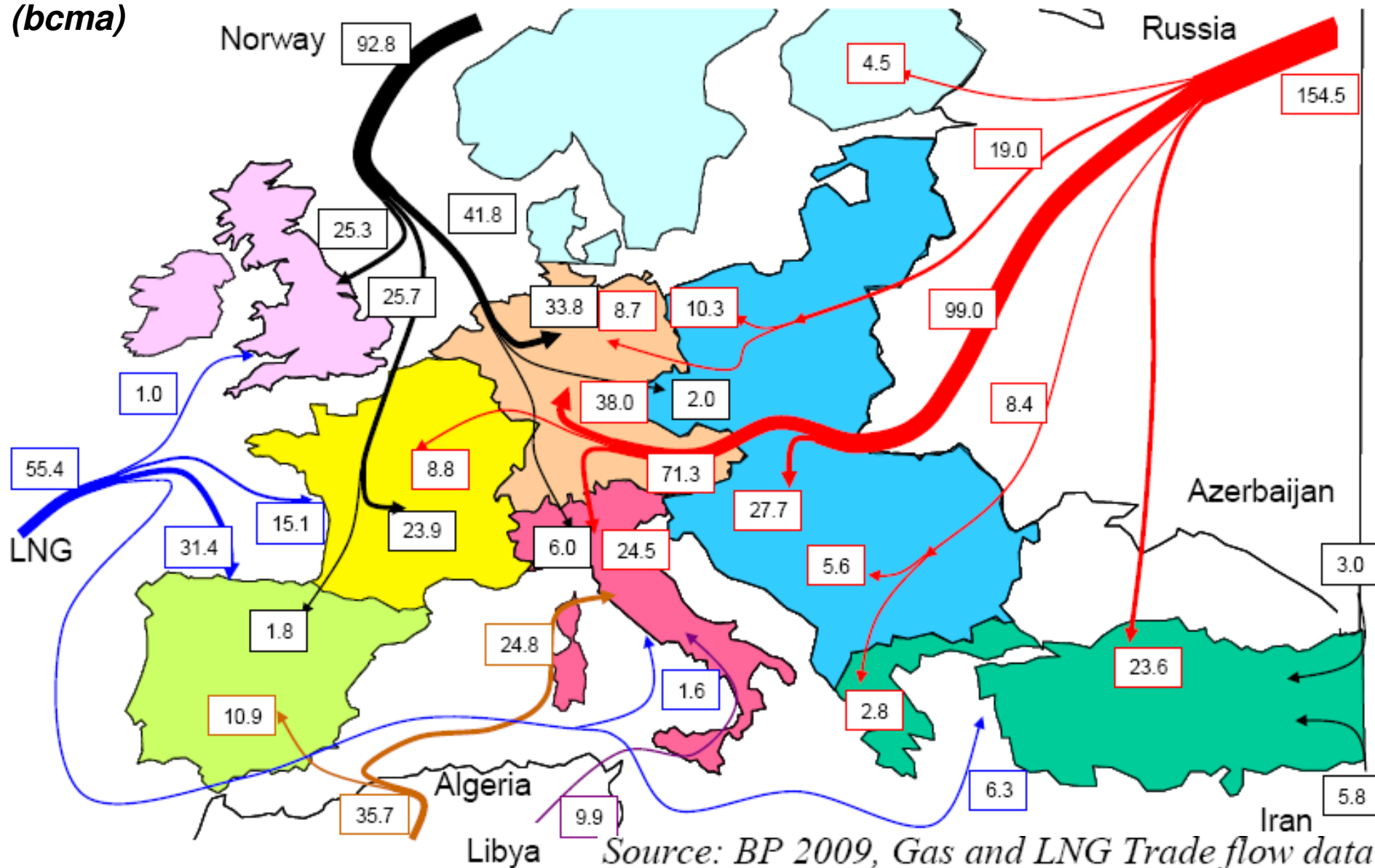



OPSKRBA PRIRODNIM PLINOM, EUROPA, 2006.

RGNF

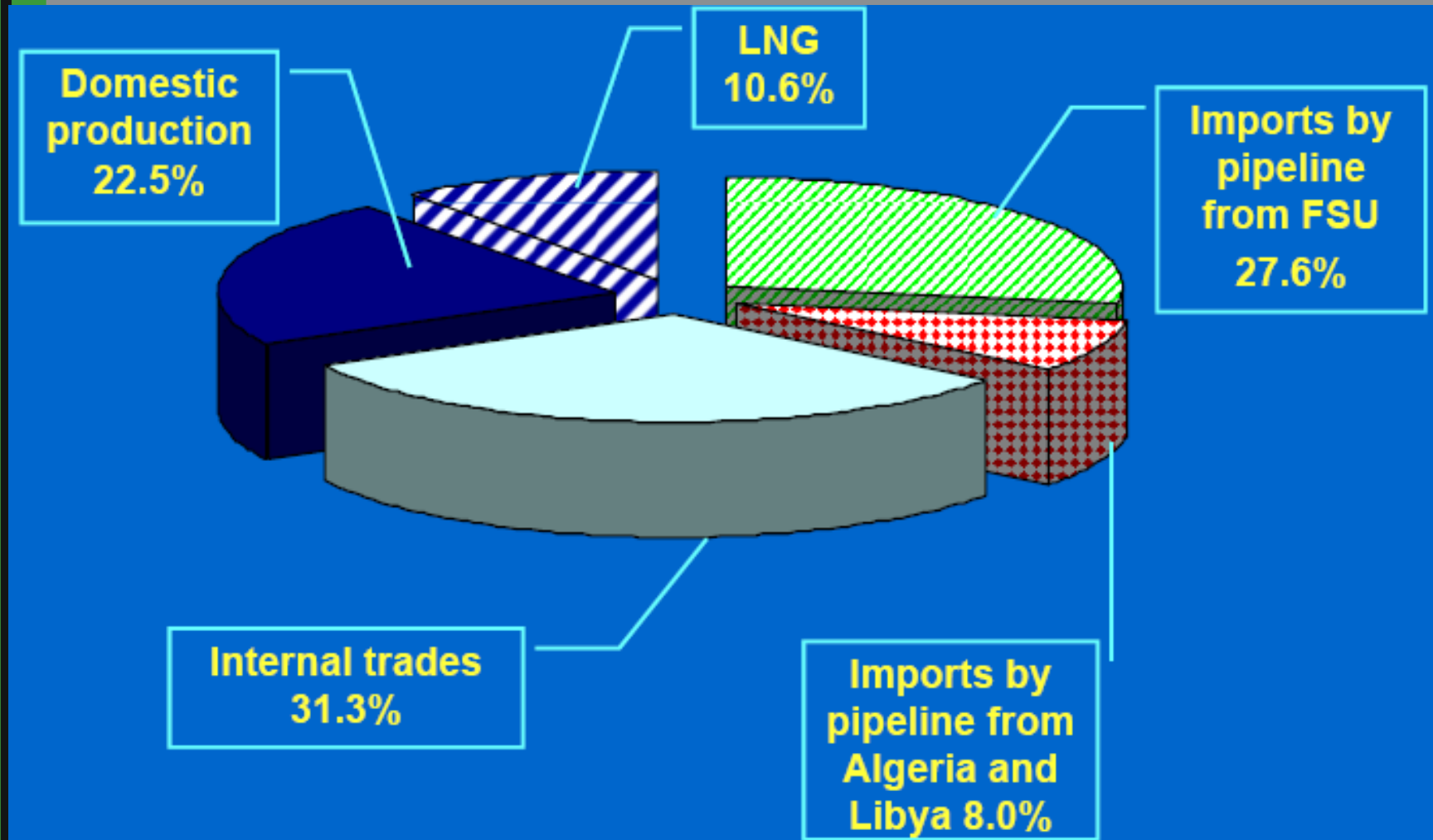



OPSKRBA UPP- om, EUROPA, 1980. – 2008.

RGNF

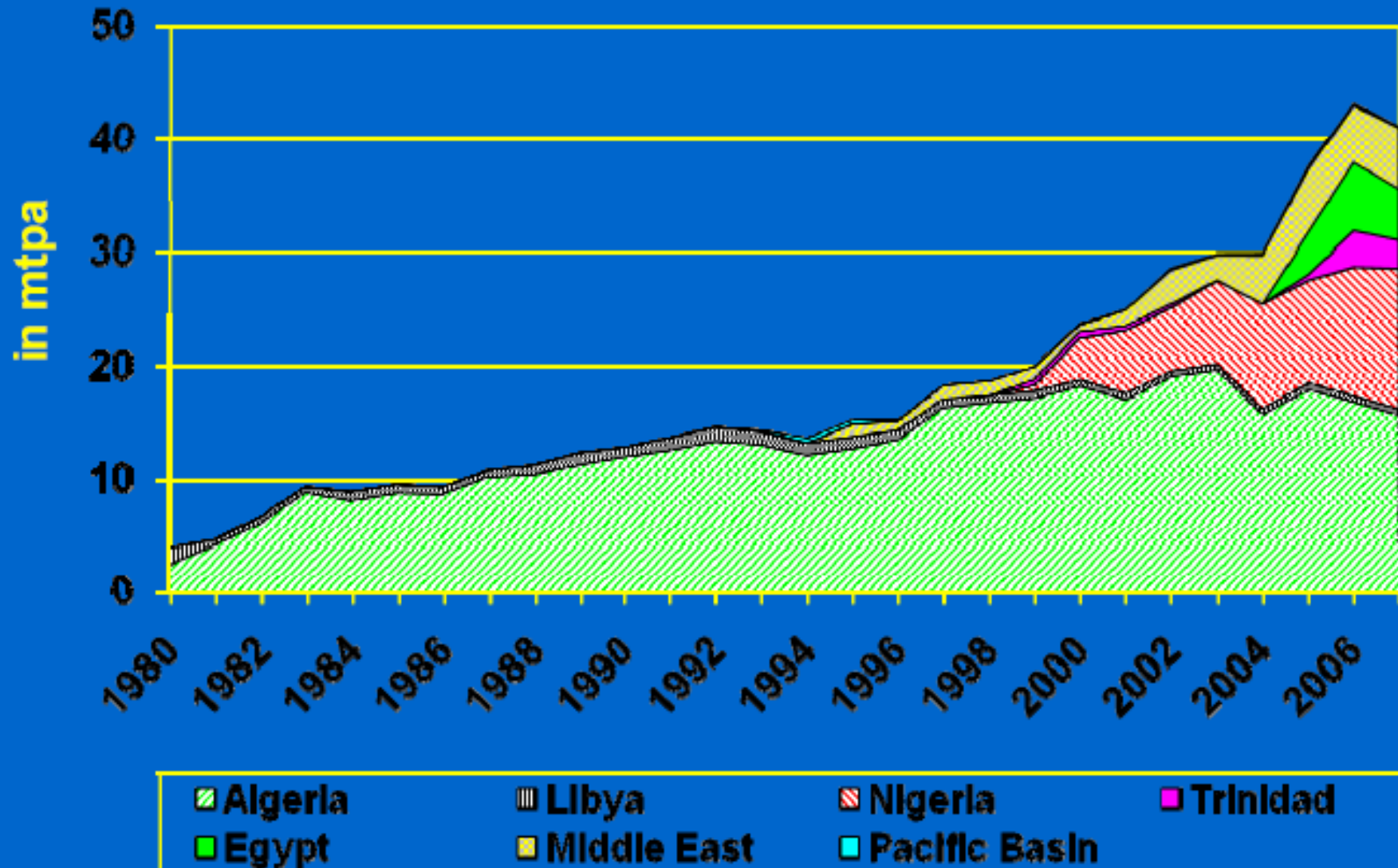



RGNF

UPP INFRASTRUKTURA U EUROPI

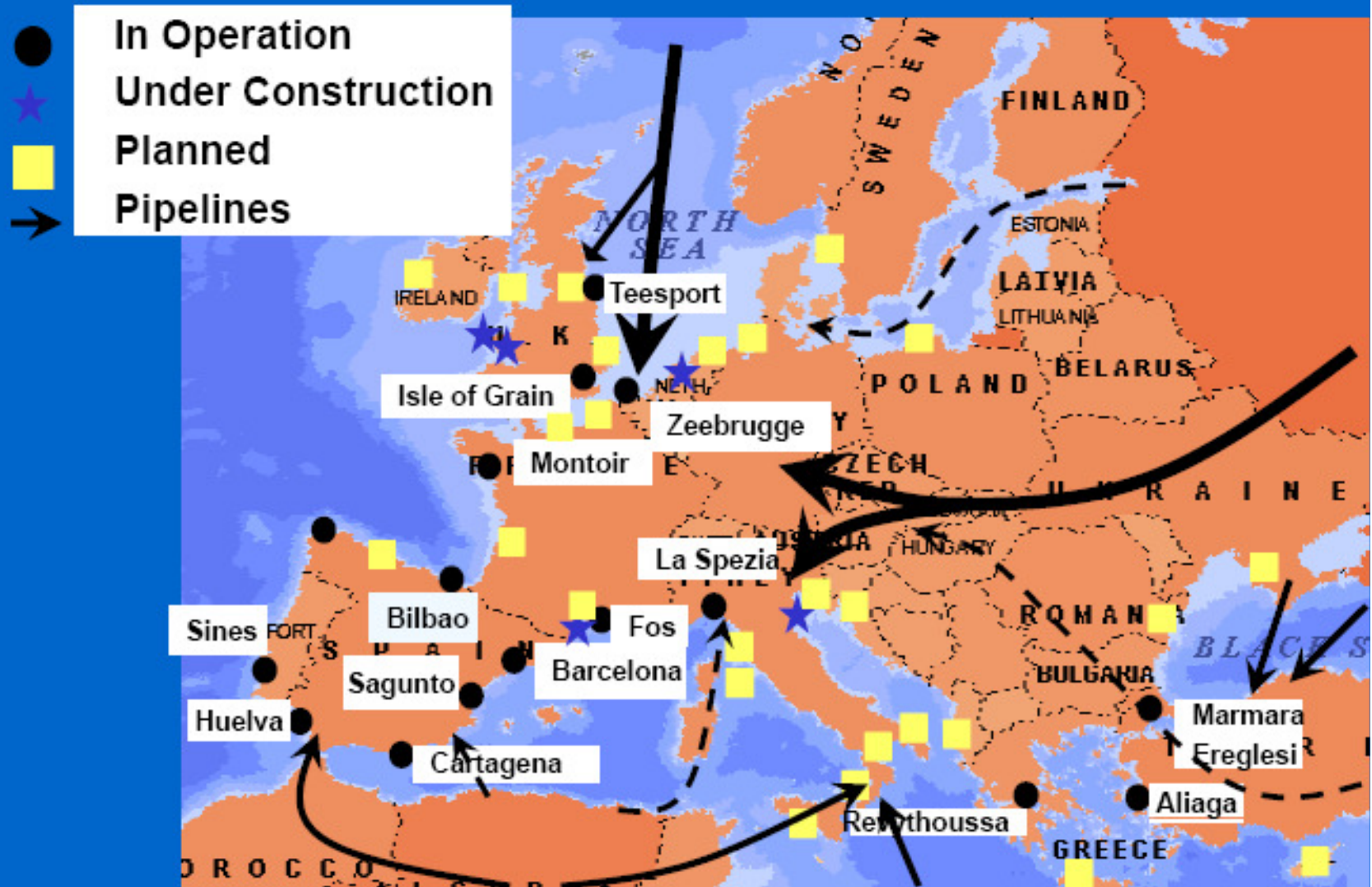



RGNF

POTREBNE KOLIČINE PRIRODNOG PLINA ZA LNG PROJEKT OD $8 \times 10^6 \text{ m}^3/\text{g}$ (20 godina)

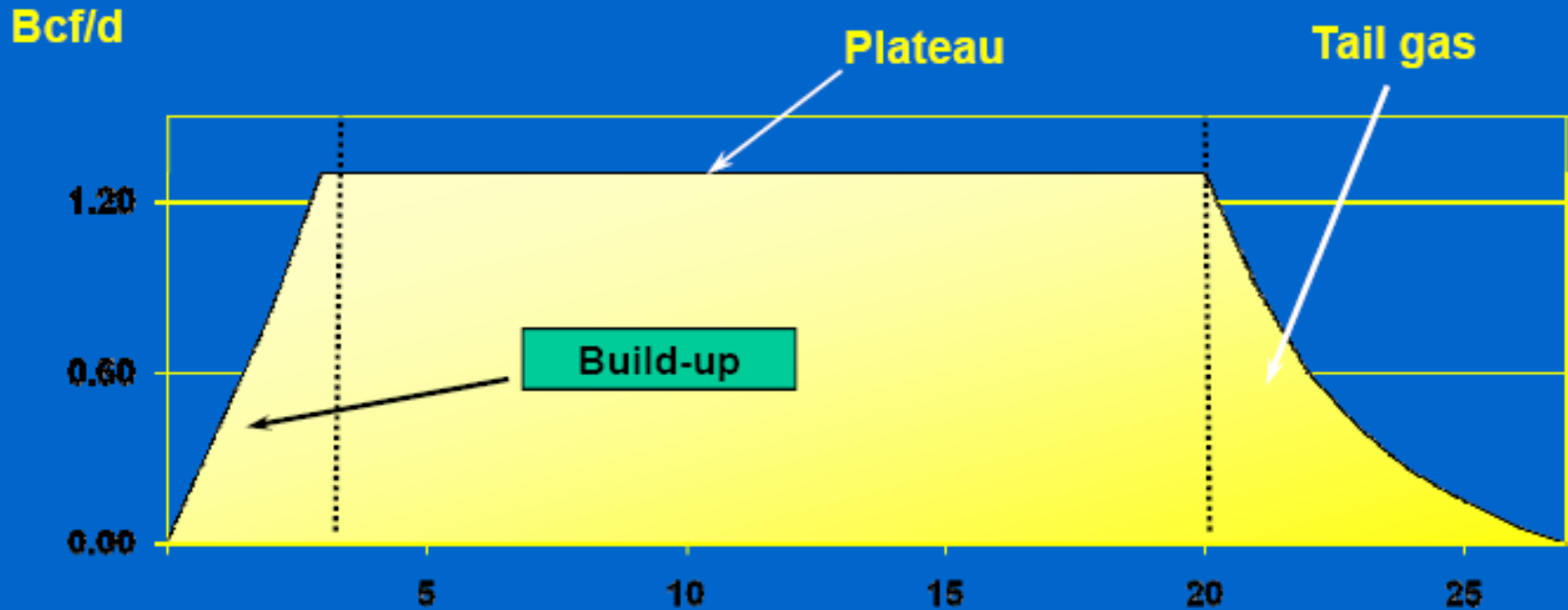

- Potrebne rezerve plina= $310 - 370 \times 10^9 \text{ m}^3$
- Gubici i pogonski plin= $85 - 140 \times 10^9 \text{ m}^3$
- Gubici:
 - Spremnici= 0,5%/d
 - Transport= 0,1- 0,15%/d



RGNF

IZVORI PRIRODNOG PLINA ZA POSTOJEĆA PROIZVODNA LNG POSTROJENJA

- Ležišta na kopnu/ ležišta na moru
 - Na kopnu
 - Alžir, Indonezija (Arun), Libija, Oman
 - Na moru
 - Australija (NW Shelf, Darwin), Abu Dhabi, Katar (Qatargas i RasGas), Trinidad i Tobago, Malezija, Egipat, Aljaska, Ekvitorijalna Gvineja, Norveška
 - I na kopnu i na moru
 - Indonezija (Bontang), Nigerija, Bruneji



RGNF

POSTROJENJA I TEHNOLOŠKI PROCESI NA POSTROJENJU ZA UKAPLJIVANJE UPP- a

- Postrojenje za prihvatanje prirodnog plina iz proizvodnih pogona
- Postrojenje za obradu prirodnog plina
- Jedinice za ukapljivanje (*LNG train*)
- Spremnici (UPP, kondenzat, UNP)
- Pristanište, vezovi i postrojenja za utovar
- Pomoćna postrojenja (električna energija, rashladna voda, zaštita od požara i dr.)



RGNF

JEDINICE ZA UKAPLIJVANJE UPP- a

- Samostalne procesne jedinice
- Većina UPP pogona ima od 2 ili više jedinica za ukapljivanje
- Povećanje kapaciteta
 - Prve jedinice= 0,3 Mt/god
 - Najveća jedinica koja trenutno radi ima kapacitet od 5,2 Mt/god (Atlantic LNG Trinidad i Tobago)
 - Trenutno je u izgradnji jedinica za ukapljivanje kapaciteta 7,8 Mt/god u Kataru



POGON ZA UKAPLJIVANJE QATARGAS- a SAGRAĐENO 2004.

RGNF





RGNF

POGON ZA UKAPLJIVANJE RAS LAFFAN SAGRAĐENO 2007.





POGON ZA UKAPLJIVANJE ATLANTIC, TRINIDAD I TOBAGO 1999.

RGNF





RGNF

POGON ZA UKAPLJIVANJE ATLANTIC, TRINIDAD I TOBAGO 2007.





Proces hlađenja prirodnog plina

RGNF

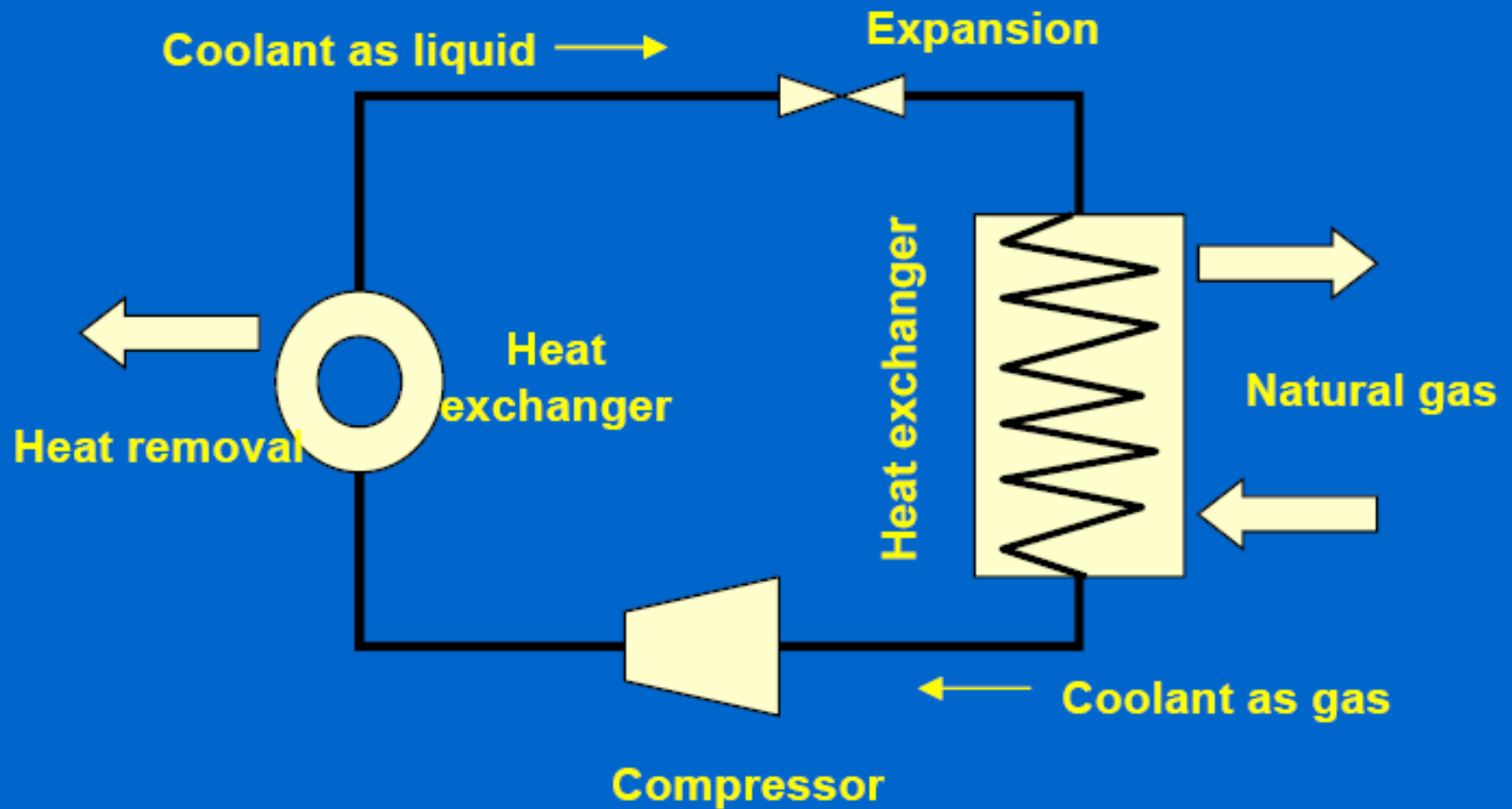



Proces ukapljivanja prirodnog plina

RGNF

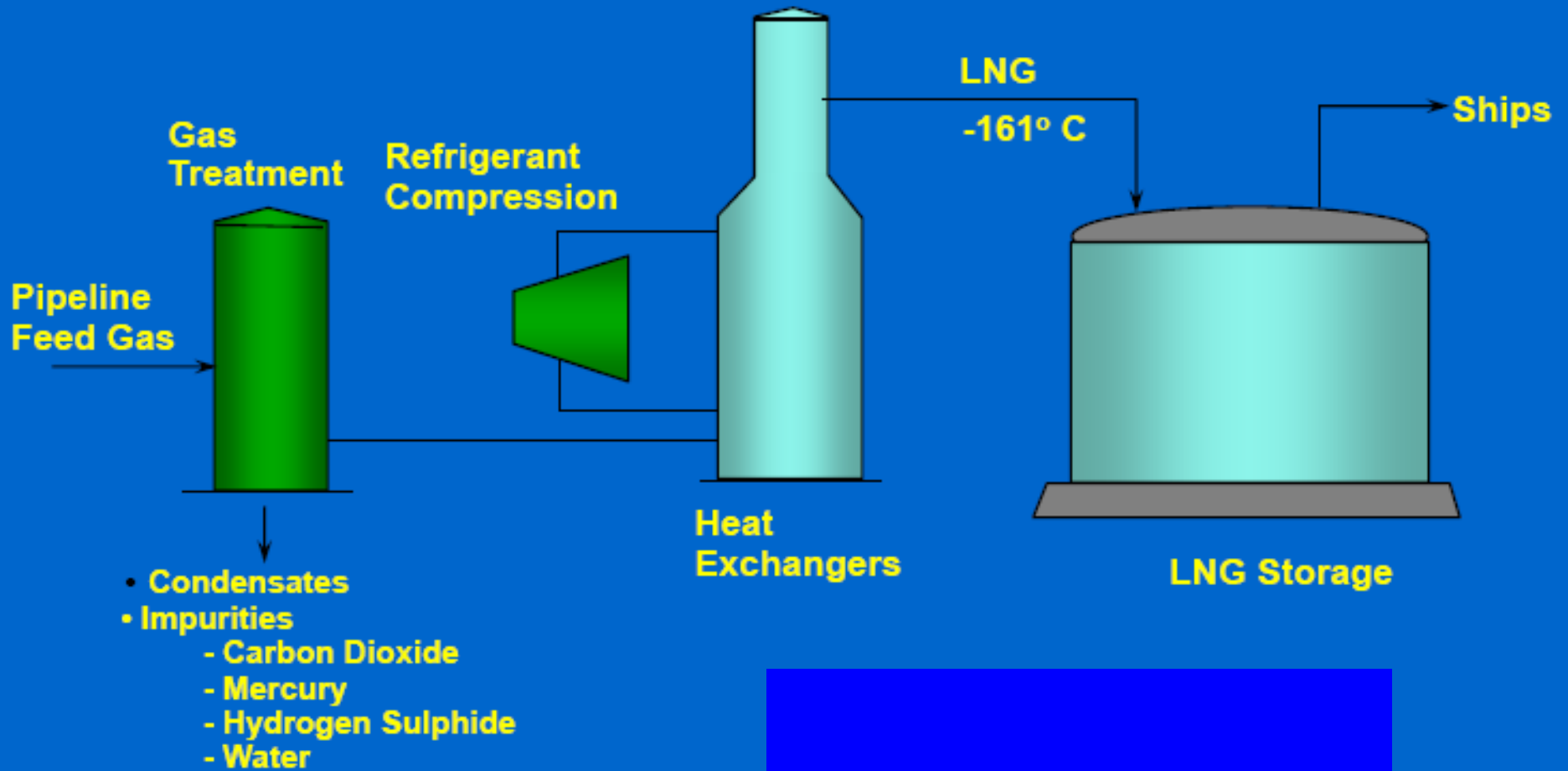



RGNF

TEHNOLOGIJA UKAPLJIVANJA PRIRODNOG PLINA

- Korištenje mješavine tvari za hlađenje (*Mixed Component Refrigerant, MCR*) (1969.- 1999.)
 - Mješavina tvari za hlađenje- C_1 , C_2 , C_3 i N_2
 - Prethodno hlađenje radnog plina (mješavine) na -35°C
 - Hlađenje prirodnog plina u spiralnom izmjenjivaču topline



RGNF

MCR PROCES

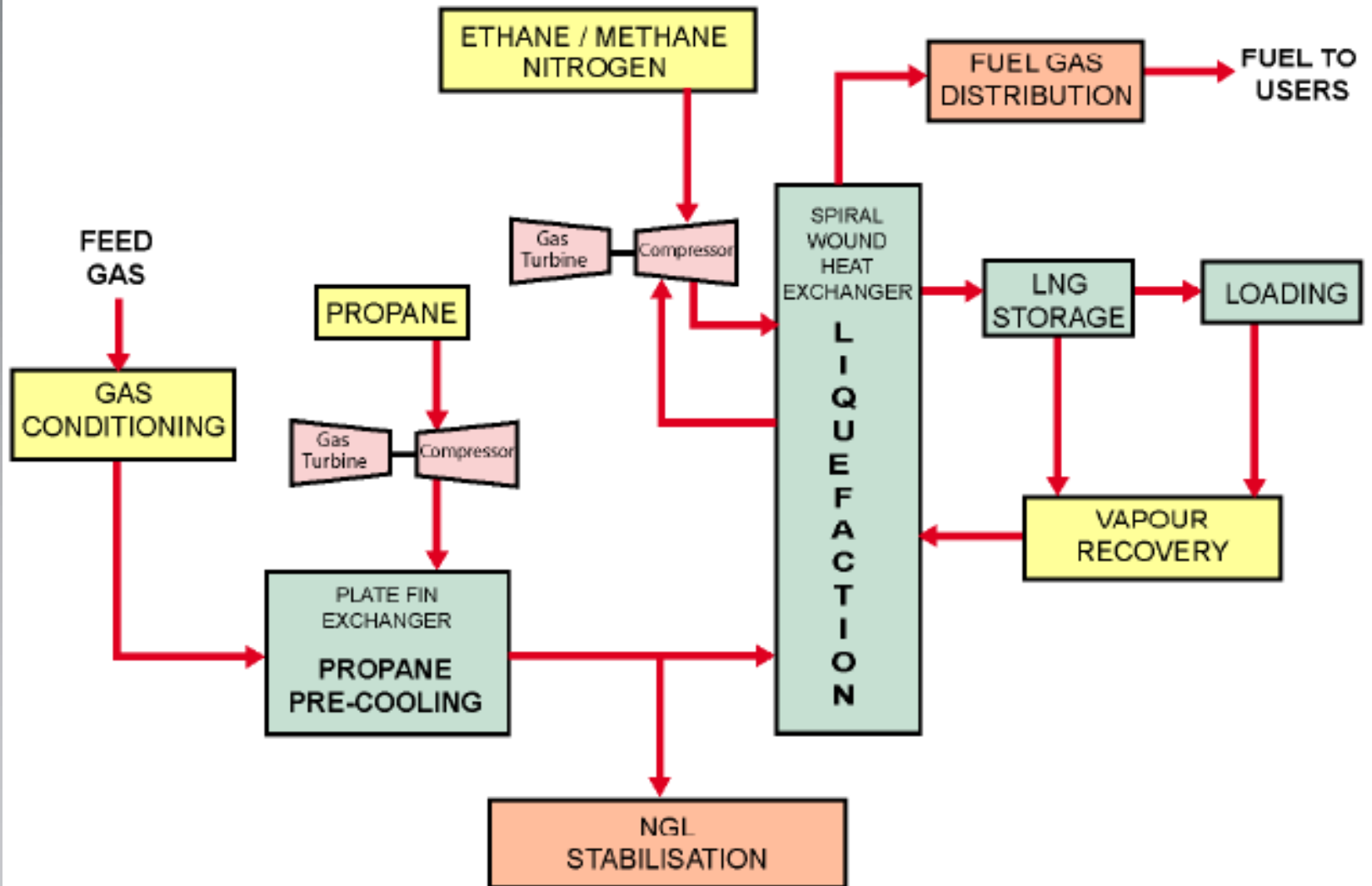



RGNF

TEHNOLOGIJA UKAPLJIVANJA PRIRODNOG PLINA

- Kaskadni proces
 - Hlađenje plina u 3 stupnja
 - C_3 hladi prirodni plin na $-35\text{ }^\circ\text{C}$
 - C_2 hladi prirodni plin na $-105\text{ }^\circ\text{C}$
 - C_1 hladi prirodni plin na $-161\text{ }^\circ\text{C}$
 - Upotreba pločastog izmjenjivača topline



KASKADNI UPP PROCES

RGNF

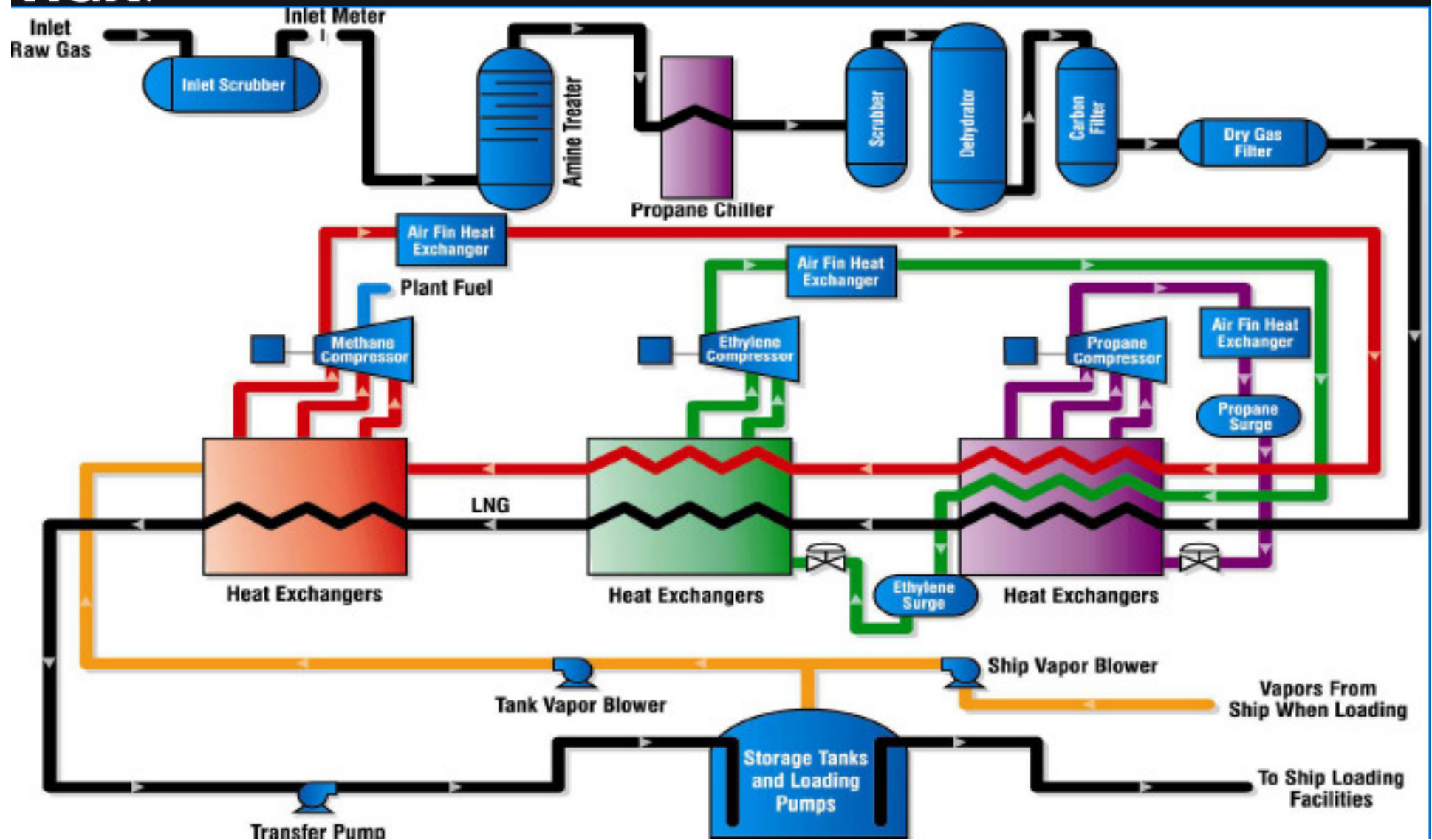



RGNF

IZMJENJIVAČ TOPLINE





RGNF

UPP SPREMNICI

- Općenito- kapaciteti spremnika zadovoljavaju potrebe punjenja 2 metanjera
- Cijena



RGNF

TROŠKOVI POSTROJENJA ZA PROIZVODNJU UPP-a

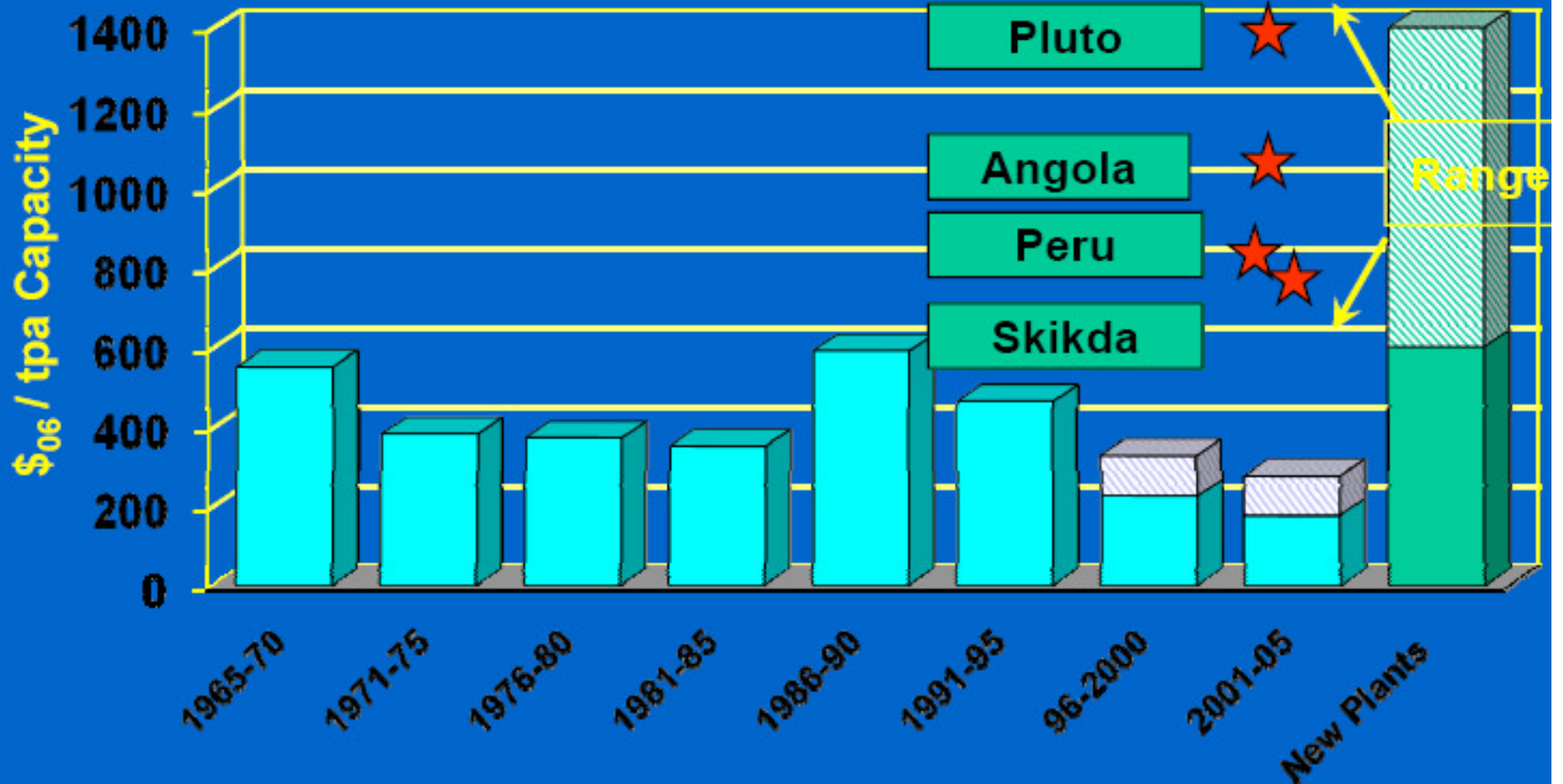



RGNF

TROŠKOVI PROSTROJENJA ZA PROIZVODNJU UPP- a

- Nadogradnja postojećih postrojenja
- Nova postrojenja
- Operativni troškovi
 - 3%- 5% početnih kapitalnih troškova
- Troškovi održavanja
 - Remont pogona za proizvodnju UPP- a (trains) jednom u tri godine u trajanju 1 mjesec



RGNF

BRODOVI ZA PRIJEVOZ UPP- a

- 1959.- *Methane Pioneer*, prvi transport LNG- a iz SAD u UK
- 1964.- prvi specijalno izrađeni LNG tankeri (*Methane Princess, Methane Progress*)
- 1975.- tankeri kapaciteta 125 000 m³ (*Hilli, Gimi*)
- 2004.- tankeri kapaciteta 145 000 m³
- 2004.- naručeni tankeri Q- Flex (217 000 m³)
- 2006.- naručeni tankeri Q- Max (270 000 m³)
- 2007.- isporučeni prvi Q- Flex tankeri



BRODOVI ZA PRIJEVOZ UPP- a

RGNF

- Membranski
 - Punjenje spremnika jedan po jedan
- Sferični (Kvaerner- Moss)
 - Ravnomjerna raspodjela tereta



BRODOVI ZA PRIJEVOZ UPP- a

RGNF





BRODOVI ZA PRIJEVOZ LNG- a

RGNF





RGNF

SPREMNICI ZA PRIJEVOZ UPP- a

- Membranski
 - Punjenje spremnika jedan po jedan (90%)
 - Niži troškovi prolaska kroz Sueski kanal (prednost u odnosu na sferične)
 - Kraće vrijeme hlađenja spremnika- 10- 15 h (sferični- 1-1,5 dan)
- Sferični (Kvaerner- Moss)
 - Ravnomjerna raspodjela tereta
- IHI- kombinacija membranskog i sferičnog
 - U obliku prizme
 - Danas takvu vrstu spremnika imaju samo dva tankera (Aljaska- Japan)



MEMBRANSKI SPREMNIK ZA PRIJEVOZ UPP- a

RGNF

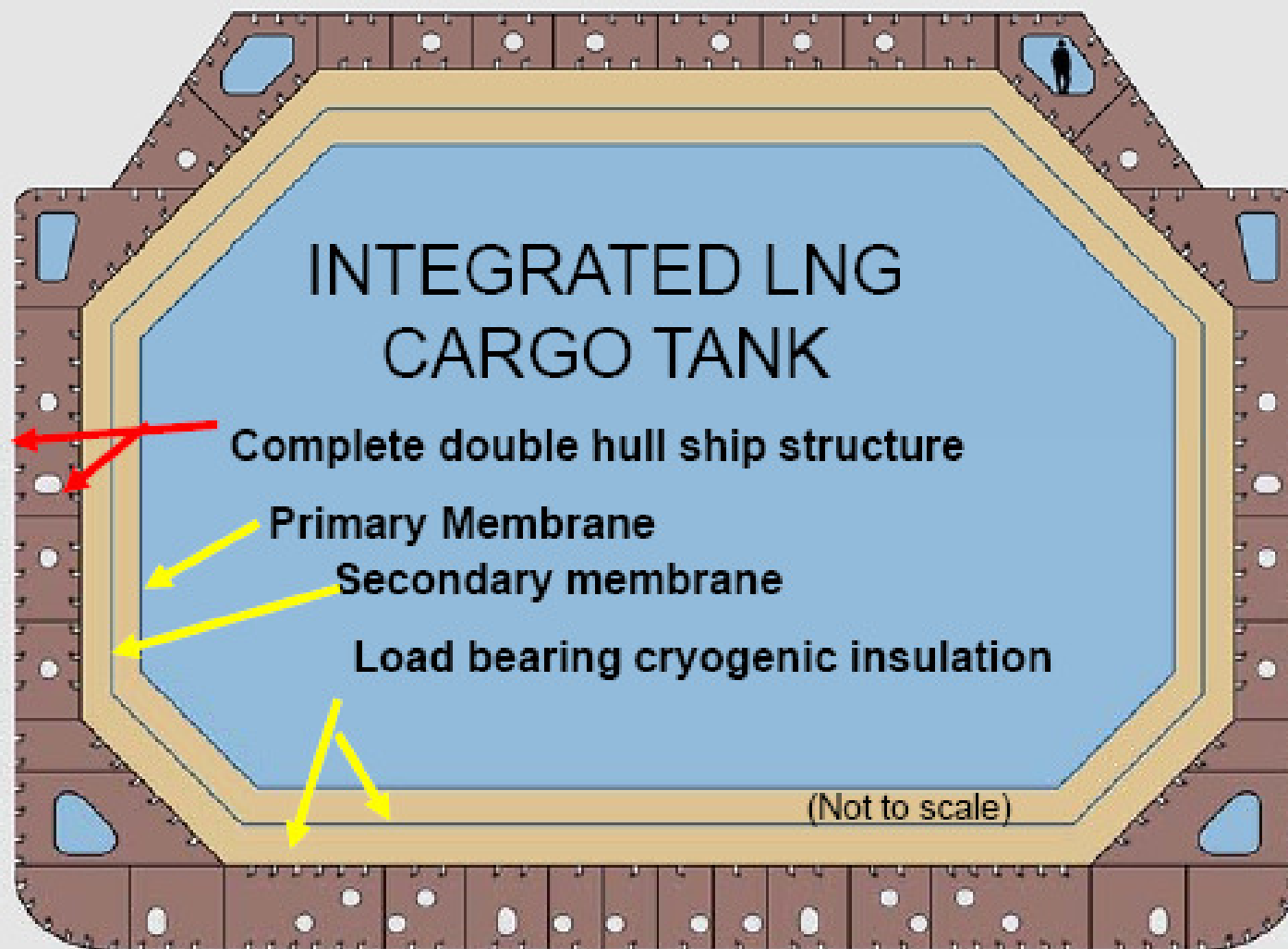



RGNF

SFERIČNI BRODOVI ZA PRIJEVOZ UPP- a





SFERIČNI BRODOVI ZA PRIJEVOZ UPP- a

RGNF





IHI SPREMNIK ZA PRIJEVOZ LNG- a

RGNF

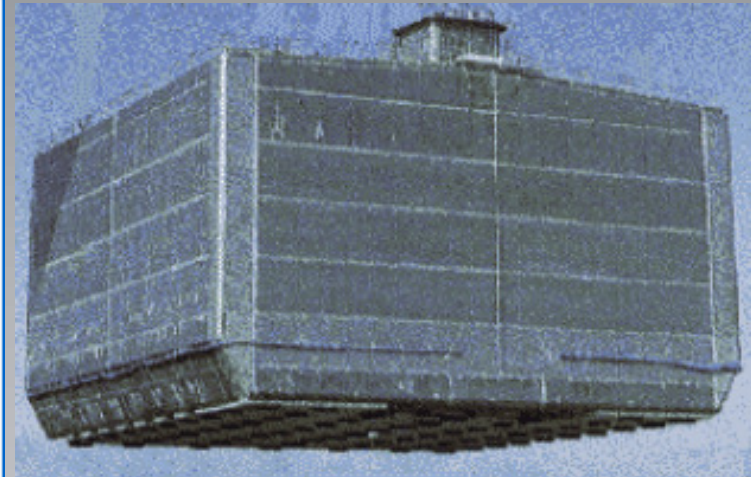
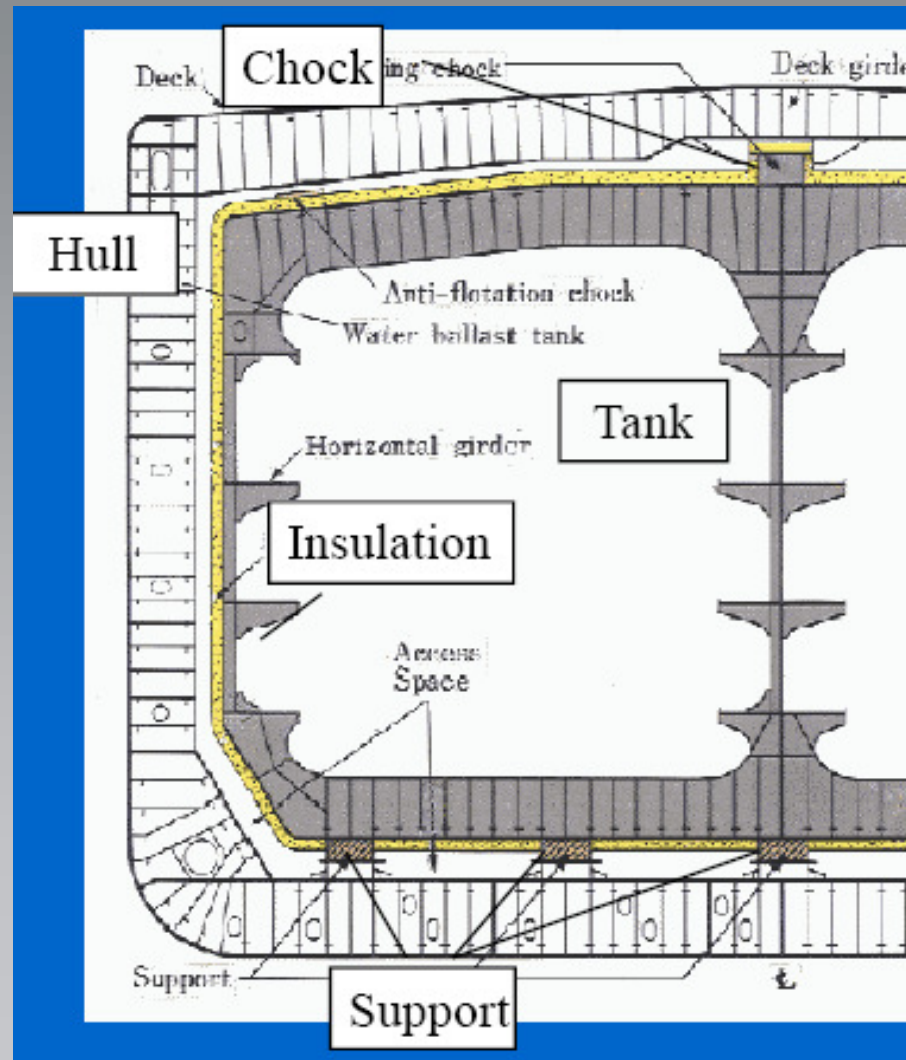



LNG BRODOVI

RGNF

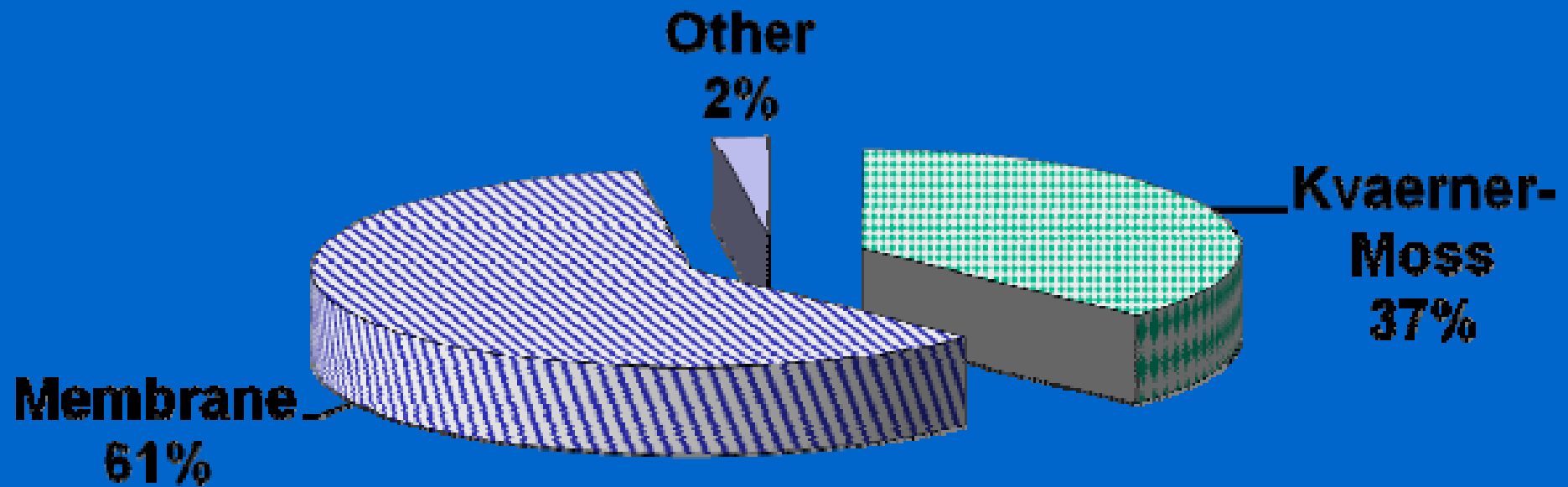



TROŠKOVI IZGRADNJE METANJERA

RGNF

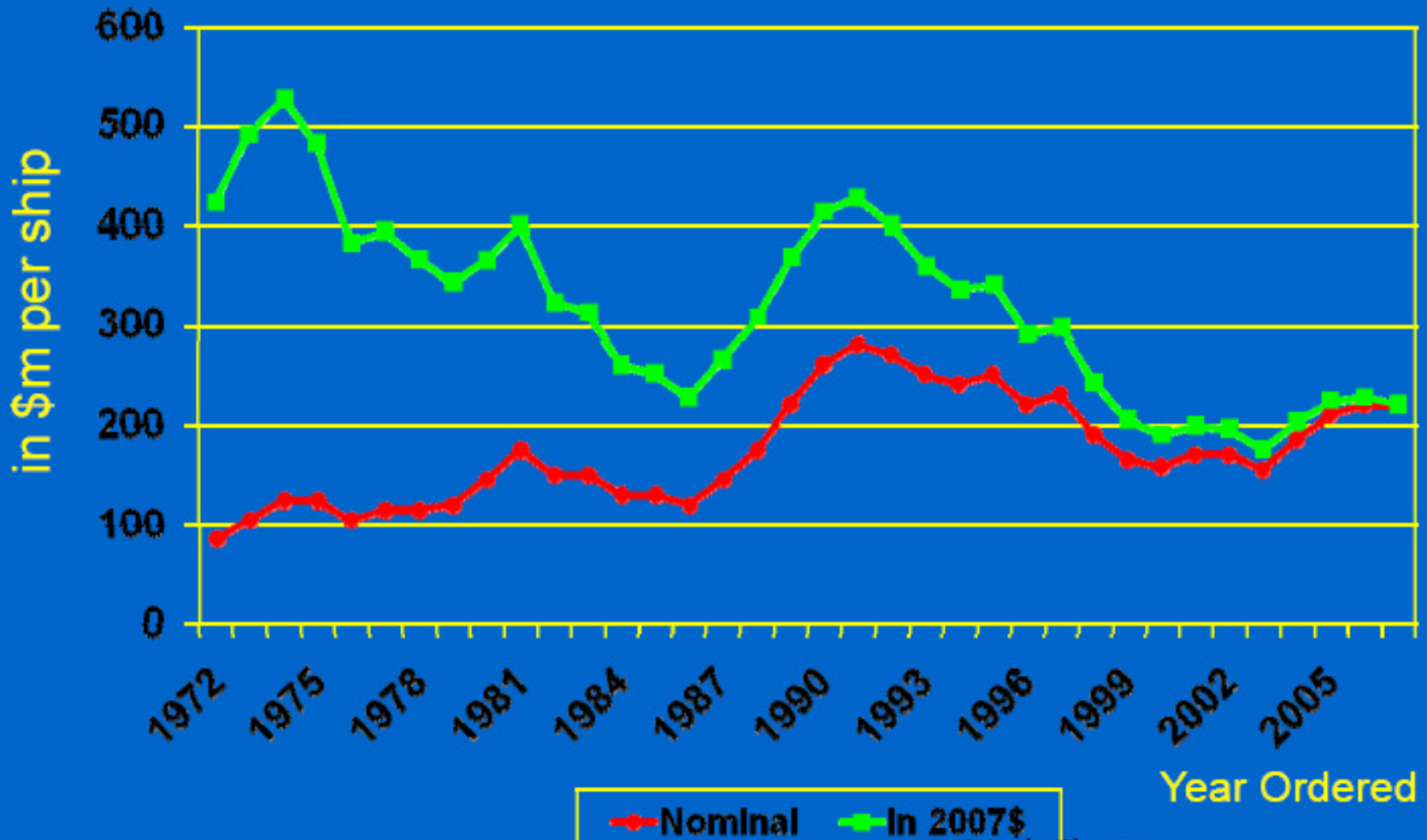



RGNF

DANAŠNJA FLOTA METANJERA

- Ožujak 2008.- 256 brodova (u funkciji 236 brodova)
 - 18 000- 50 000 m³ = 16
 - 51 000- 120 000 m³ = 17
 - 122 000- 155 000 m³ = 251
 - 210 000- 216 000 m³ = 8



STAROST METANJERA

RGNF

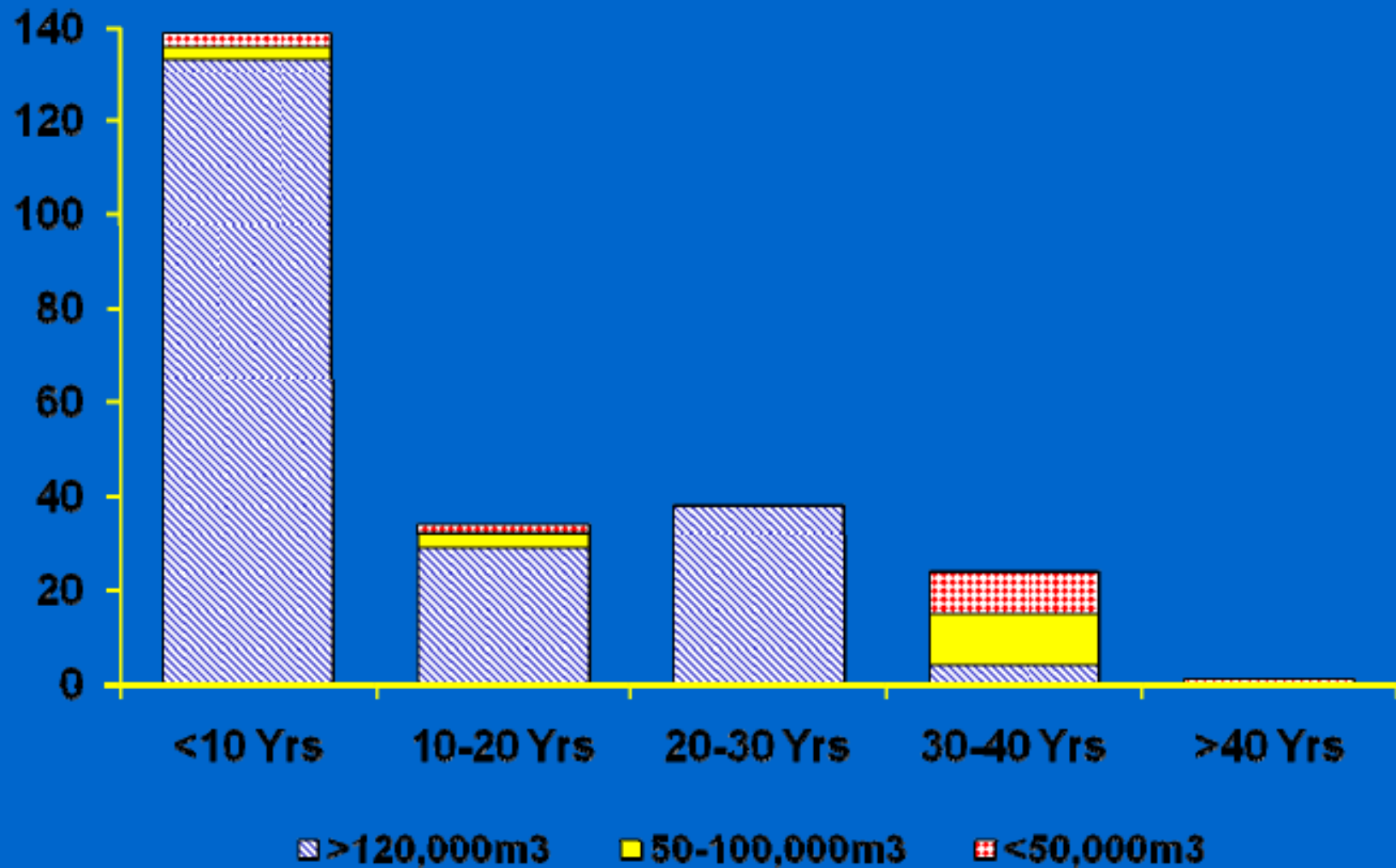



RGNF

BUDUĆA FLOTA METANJERA

- Ožujak 2008.- naručeno 123 brodova
 - 75 500- 90 000 m³ = 4
 - 145 000- 177 000 m³ = 82
 - 210 000- 266 000 m³ = 37

- Cijena metanjera od 155 000 m³ = oko 225×10⁶ \$



RGNF

PRIHVATNI LNG TERMINALI (UPLINJAVANJE) KOJI MOGU PRIHVATITI Q- Flex BRODOVE

- Terminali u funkciji
 - Europa = Zeebrugge, Montior, Bilbao
 - SAD = otok Elba ?
 - Meksiko = Altamira
 - Japan = Niigata
 - Korea = Pyong- Taek, Incheon ?



RGNF

PRIHVATNI LNG TERMINALI (UPLINJAVANJE) KOJI MOGU PRIHVATITI Q- Flex BRODOVE

- Terminali koji uz male preinake mogu prihvatiti Q- Flex
 - Europa = Sagunto (Španjolska)
 - SAD = Lake Charles
 - Japan = Ohgishima, Futtsu, Sodeguara, Kawagoe, Chita, Senoboku
 - Koreja = Tongyeong
 - Kina = Guangdong
 - Indija = Dahej



RGNF

PRIHVATNI LNG TERMINALI (UPLINJAVANJE) KOJI MOGU PRIHVATITI Q- Flex BRODOVE

- Terminali koji se grade
 - Azija = Šangaj
 - Europa = South Hook (UK), Dragon, Fos Cavaou (Francuska), Gate (Nizozemska), Rovigo (Italija)
 - SAD = Sabine Pass, Freeport, Golden Pass, Cameron
 - Meksiko = Costa Azul



RGNF

FLOTA METANJERA

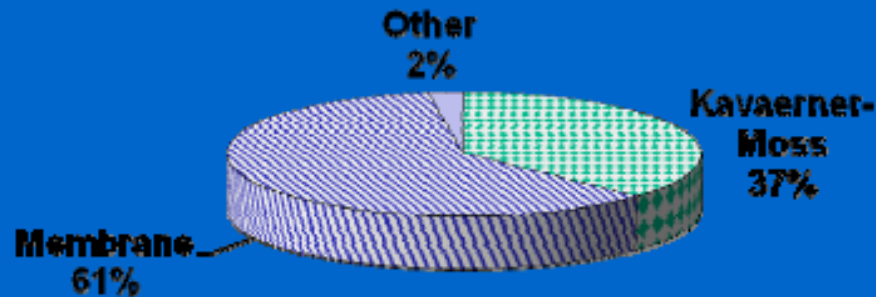

Existing Fleet (256 ships)

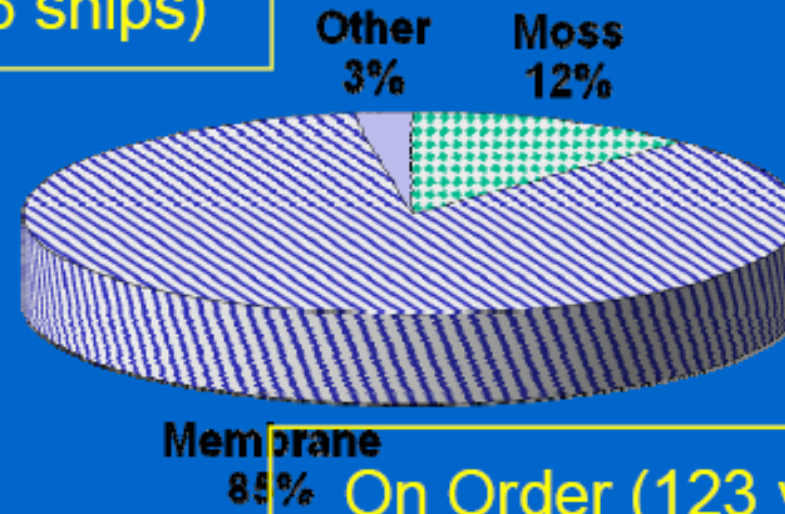

On Order (123 vessels)



UPP FLOTA

RGNF

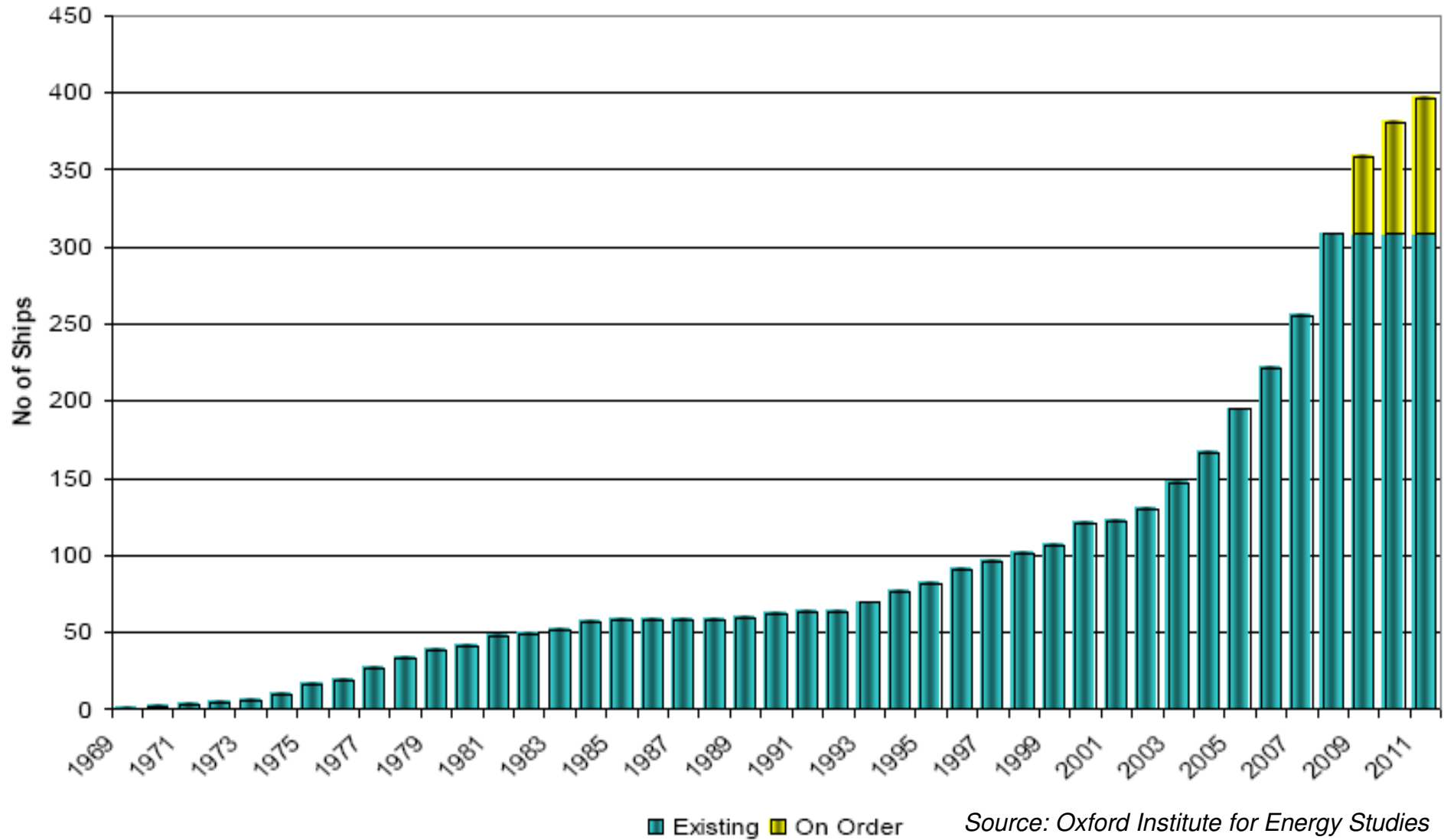



BUDUĆA FLOTA METANJERA

RGNF

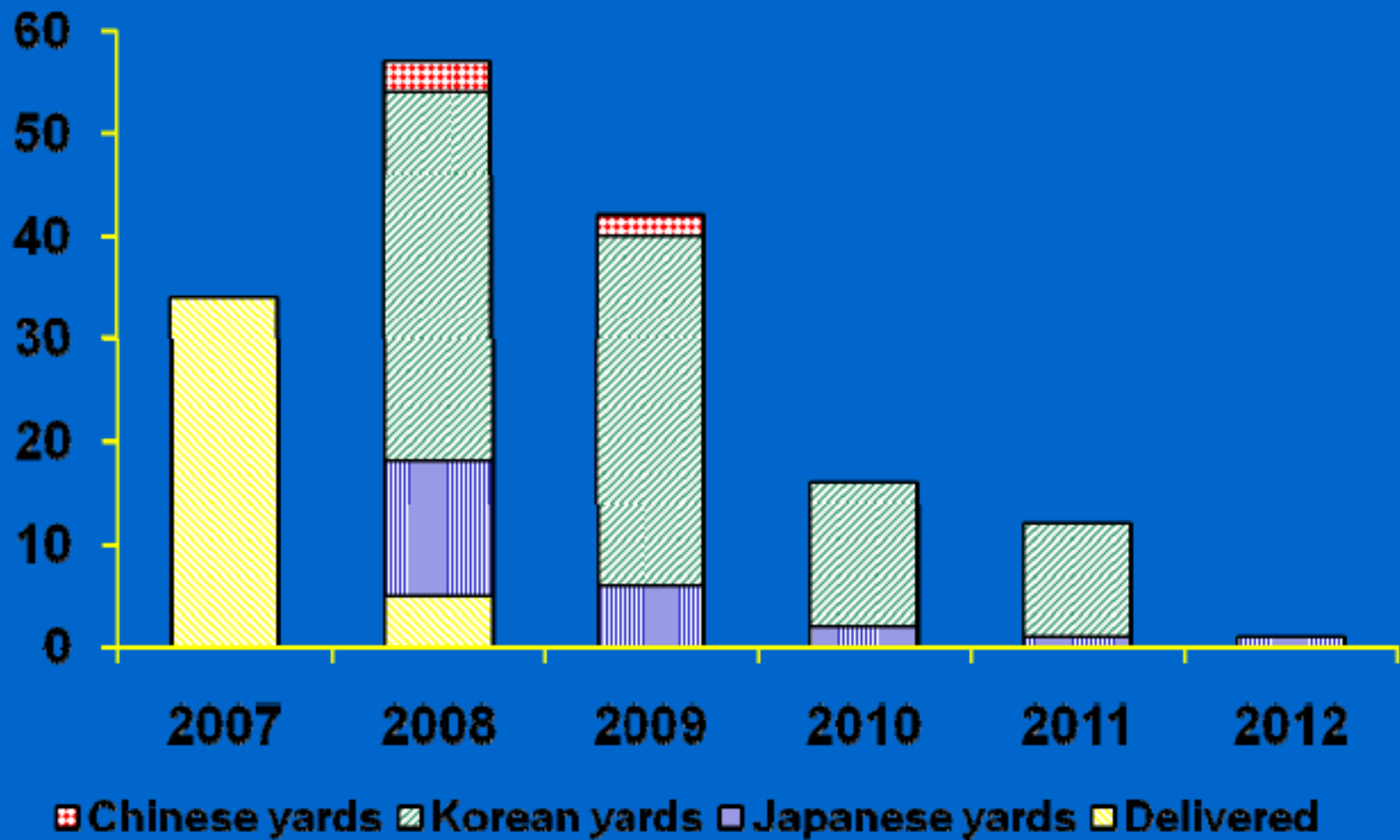



KAPACITET METANJERA

RGNF

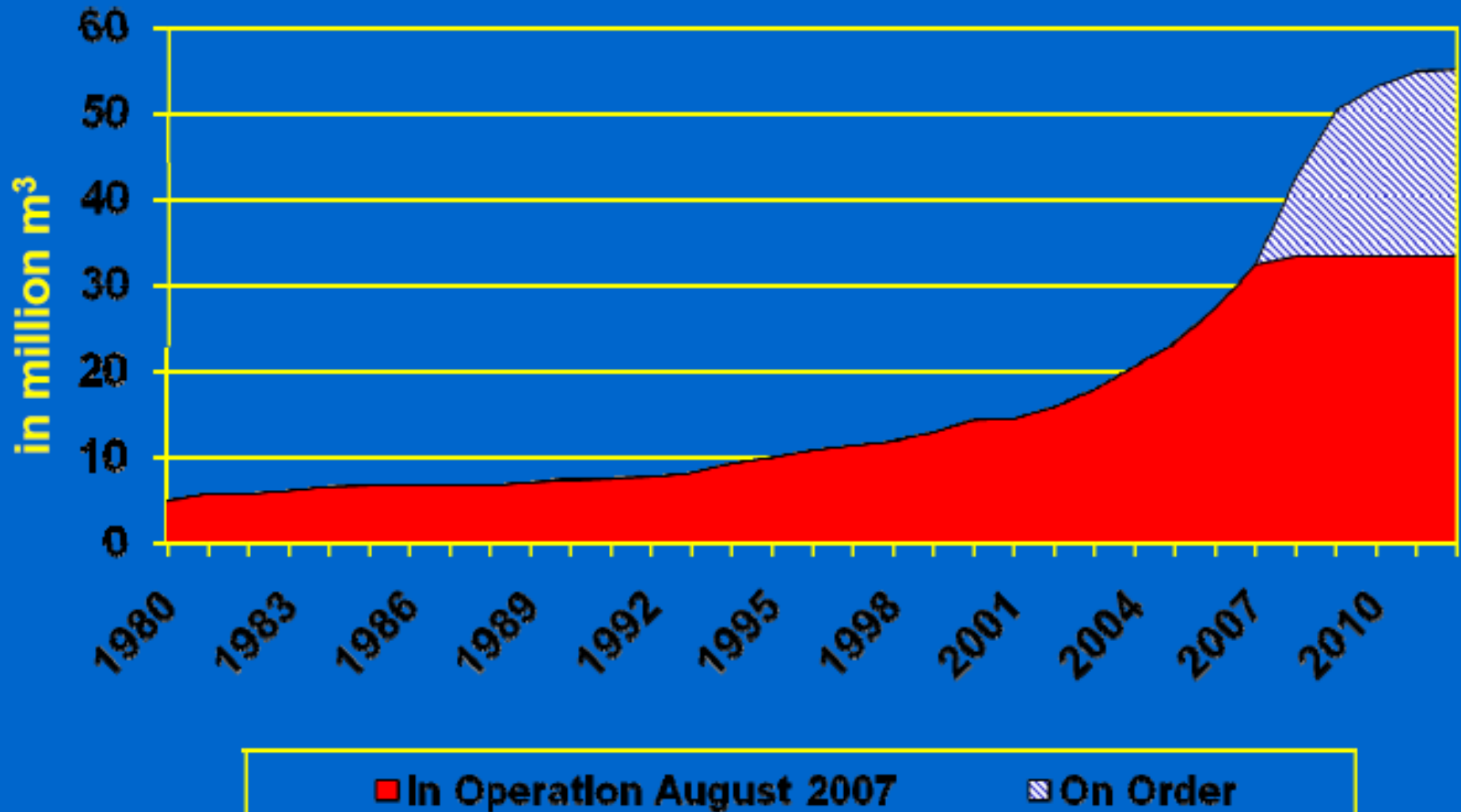



RGNF

PRIHVATNI LNG TERMINALI (UPLINJAVANJE)

- Prihvatni dokovi i istakaače ruke
- Spremnici
- Pogoni za uplinjavanje
- Plinovodi



RGNF

PRIHVATNI LNG TERMINALI (UPLINJAVANJE)

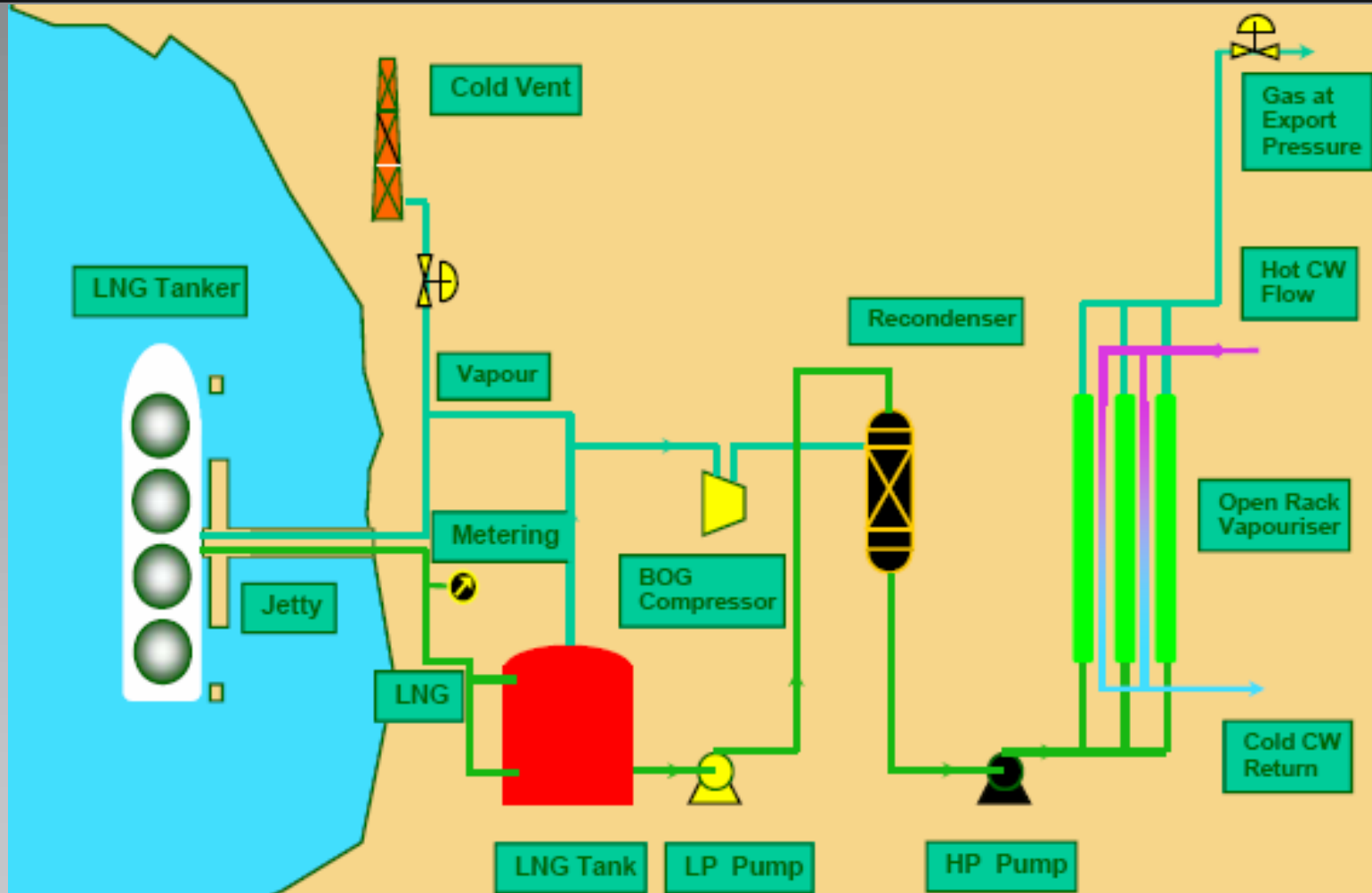



TRGOVINA UPP-om

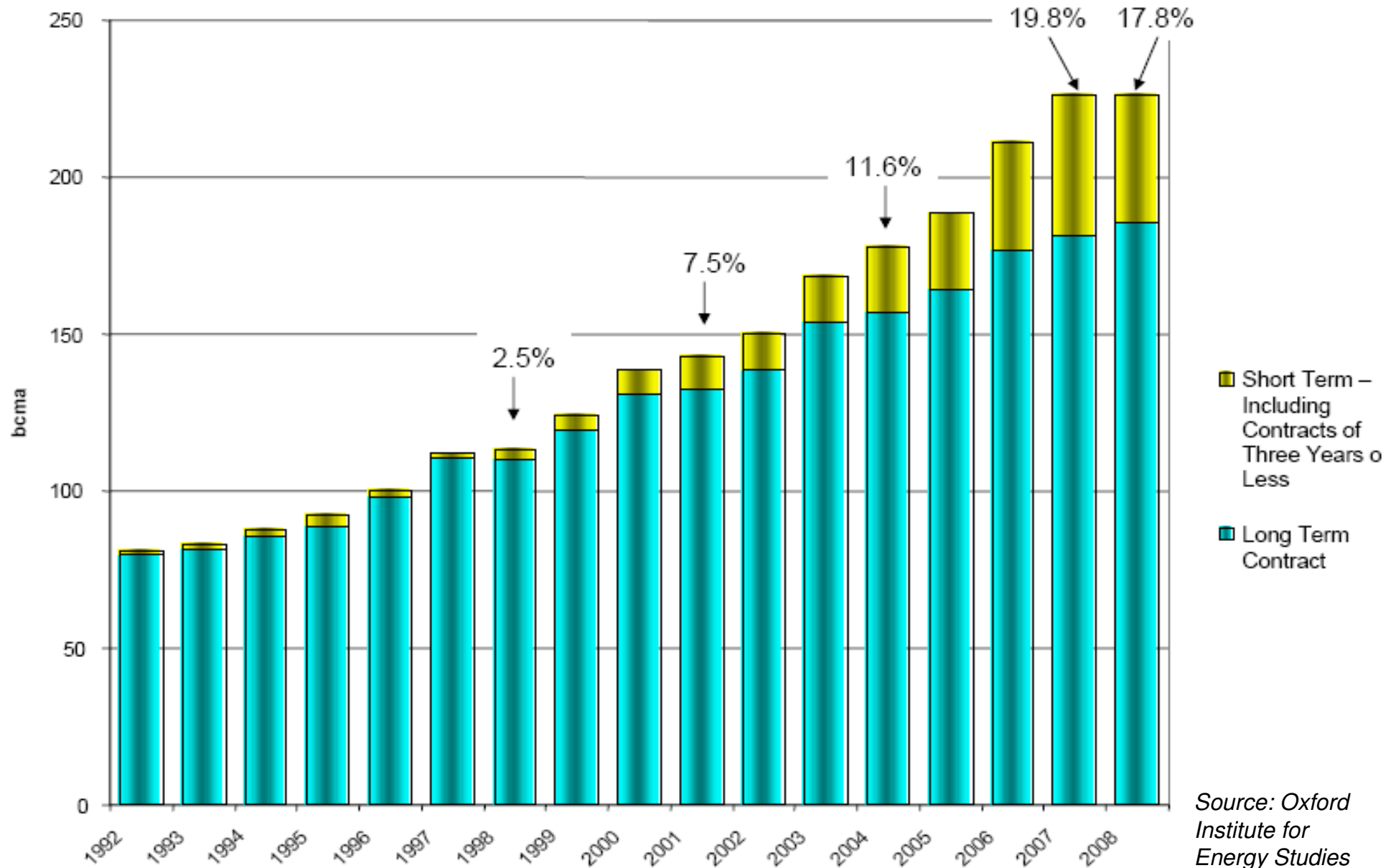

Source: Oxford Institute for Energy Studies



REGIONALNE UGOVORNE OBVEZE

RGNF

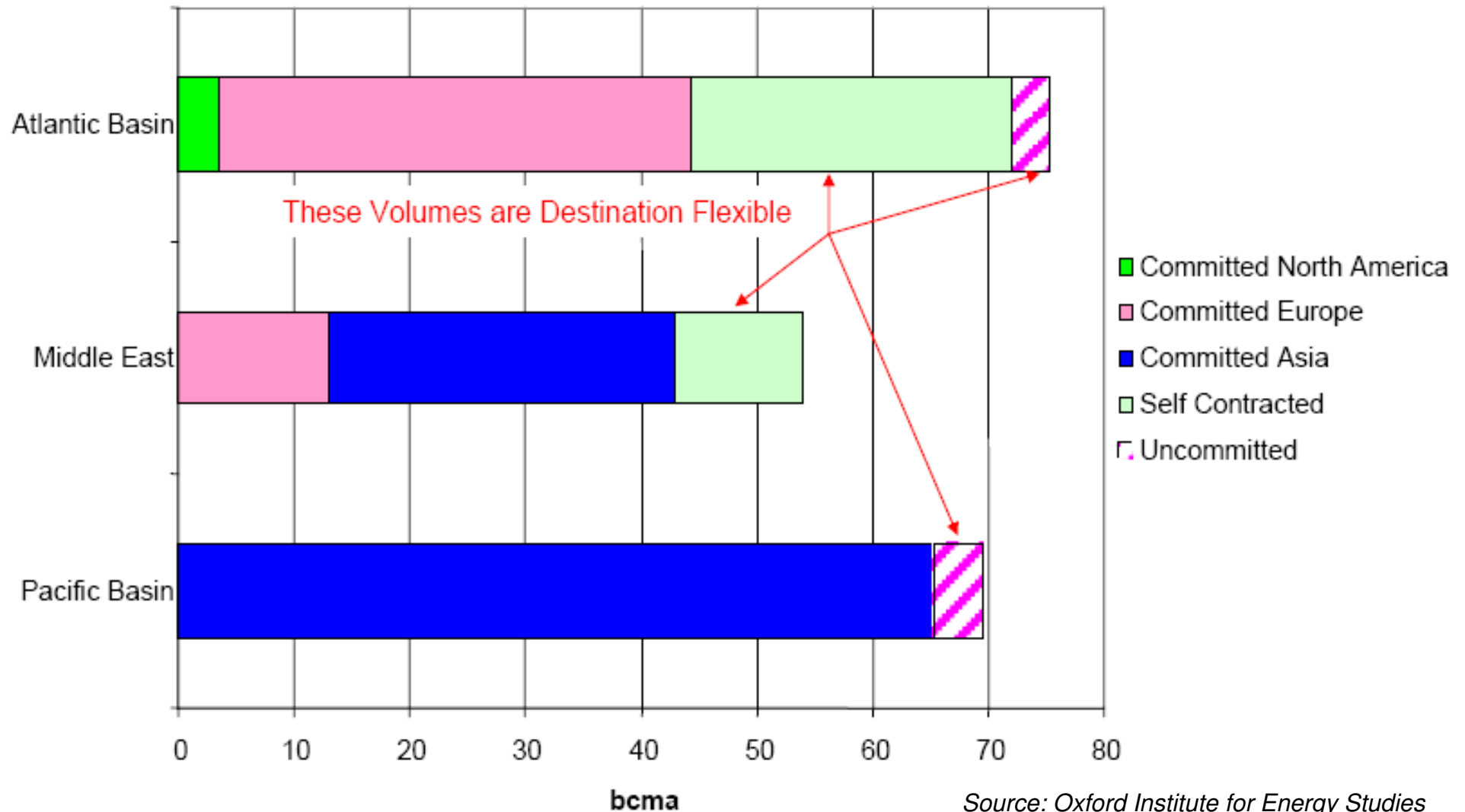

Source: Oxford Institute for Energy Studies



SADAŠNJA I POTENCIJALNA DOBAVA UPP-a

RGNF

LNG Supply 2008 - 2015

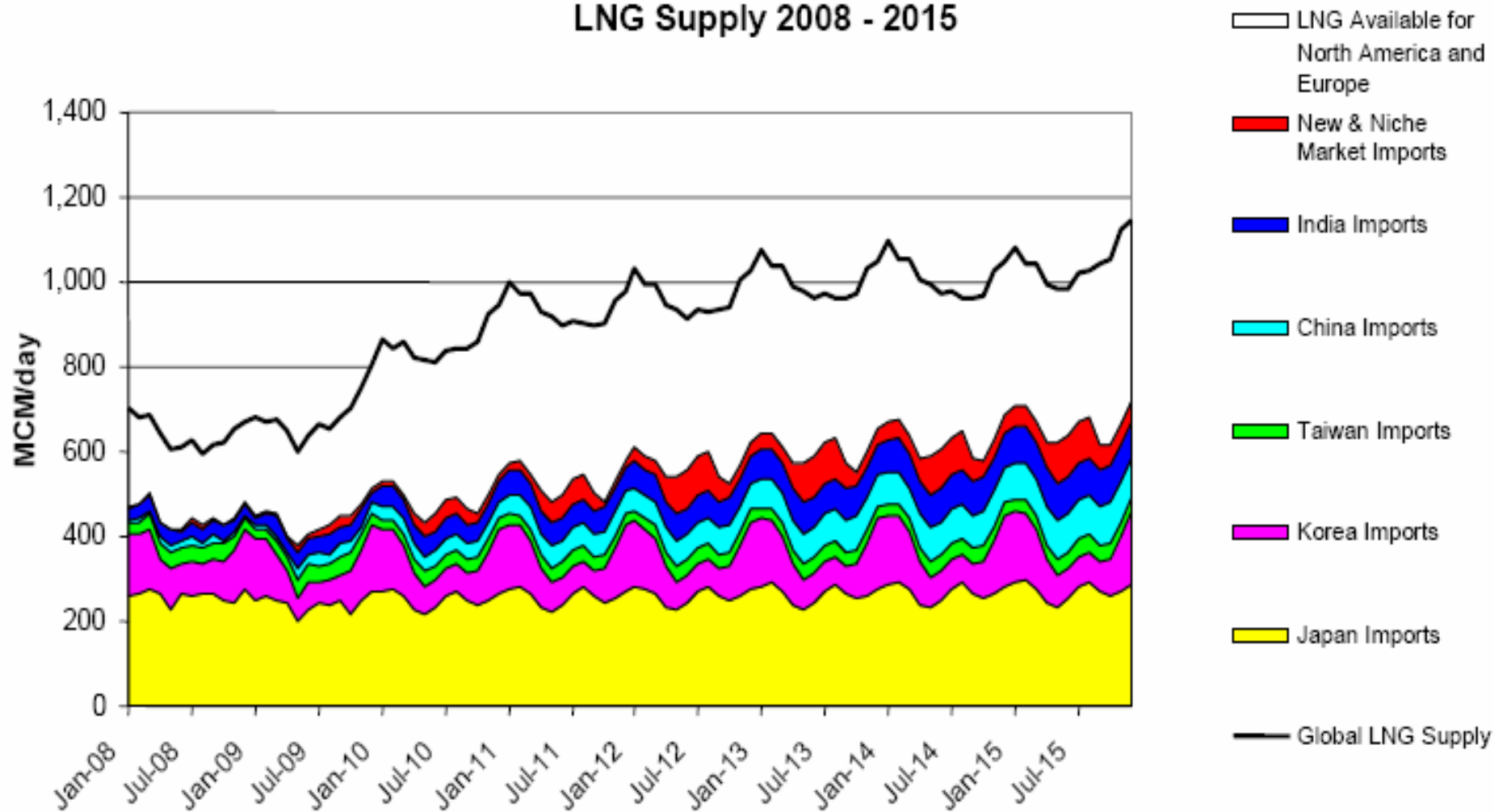

Source: Oxford Institute for Energy Studies



MAKSIMALNI UVOZNI KAPACITETI U EUROPI

RGNF

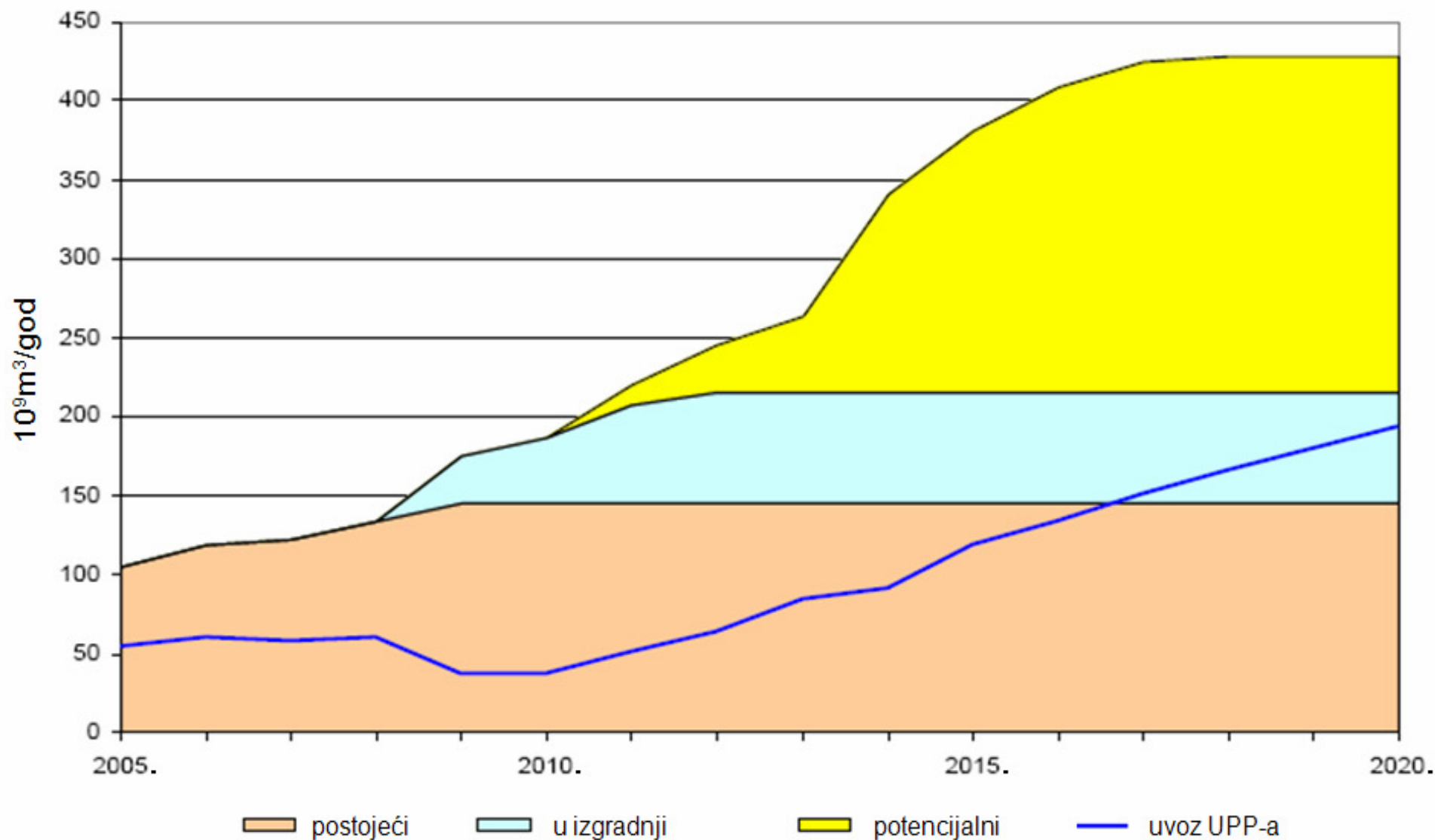



RGN

PROJEKCIJE GLOBALNE POTRAŽNJE ZA UPP-om

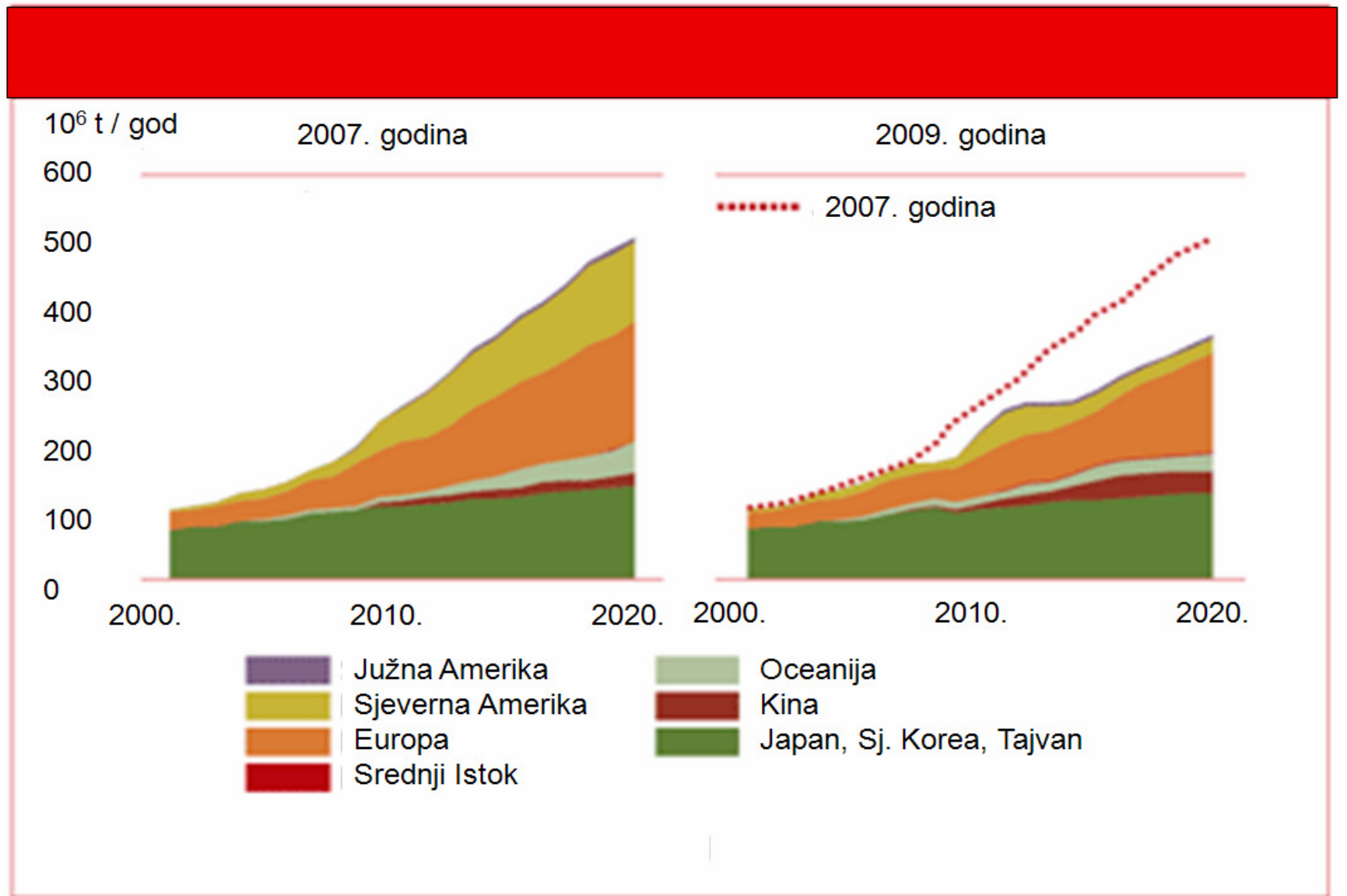



NOVI UVOZNICI UPP-a OD 2007.

RGNF

Since 2007 (April)

Argentina
Brazil
Canada
Chile
Kuwait

By 2013

Dubai
Germany
Netherlands
Pakistan
Singapore
South Africa
Thailand

Potential by 2020

Canary Islands
Croatia
Cyprus
Indonesia
Ireland
Israel
Jamaica
New Zealand
Malaysia
Philippines
Poland
Uruguay

Wild cards

Albania
Bahrain
Bulgaria
Colombia
Morocco
Panama
Romania
Sri Lanka
Ukraine
Vietnam

Bold, red countries were not included in the outlook in 2007

Source: Wood Mackenzie



GODIŠNJA POTRAŽNJA NA NOVIM TRŽIŠTIMA UPP-a

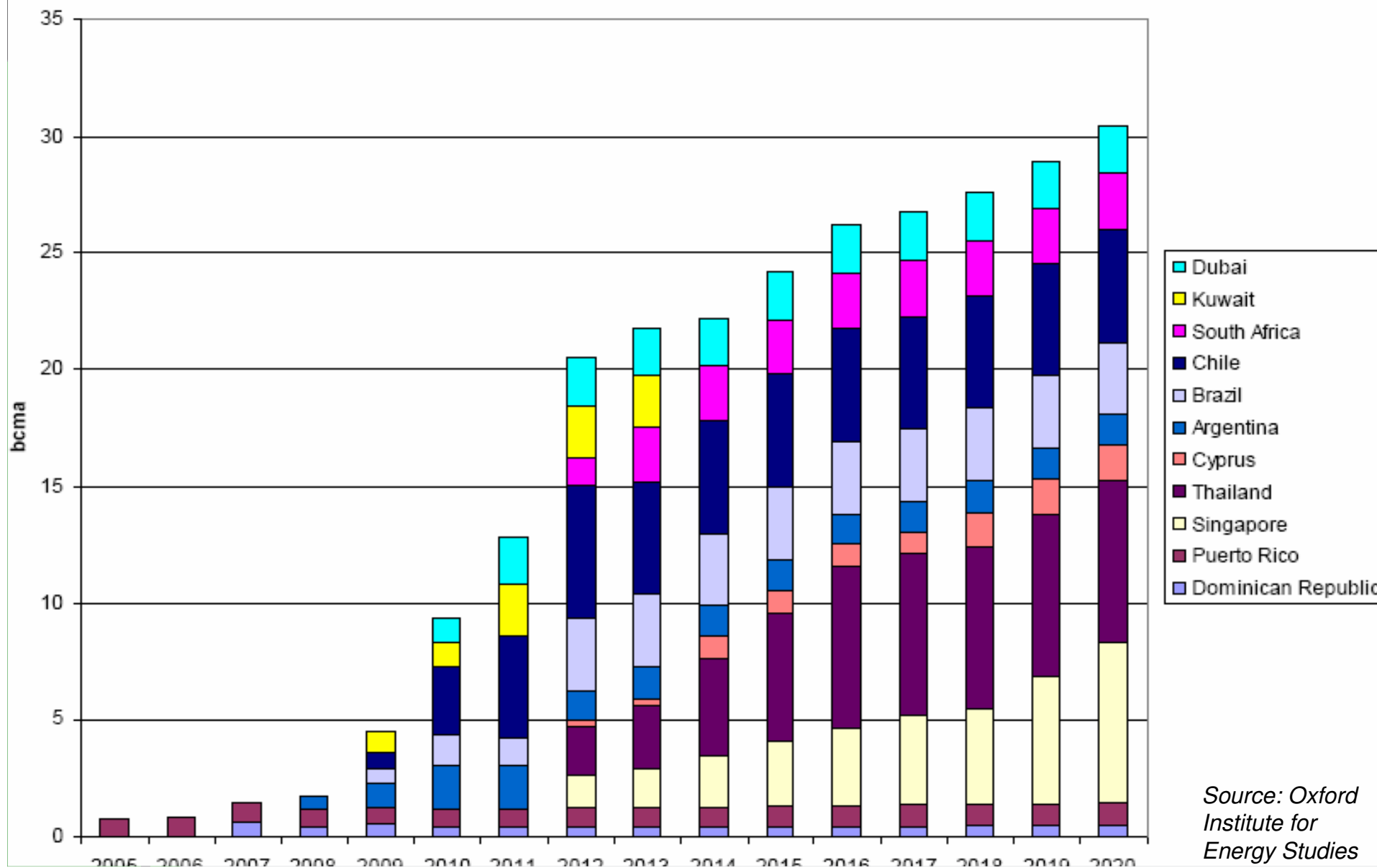

Source: Oxford Institute for Energy Studies



RGNF

PREDVIĐANJE GLOBALNE POTRAŽNJE ZA UPP-om

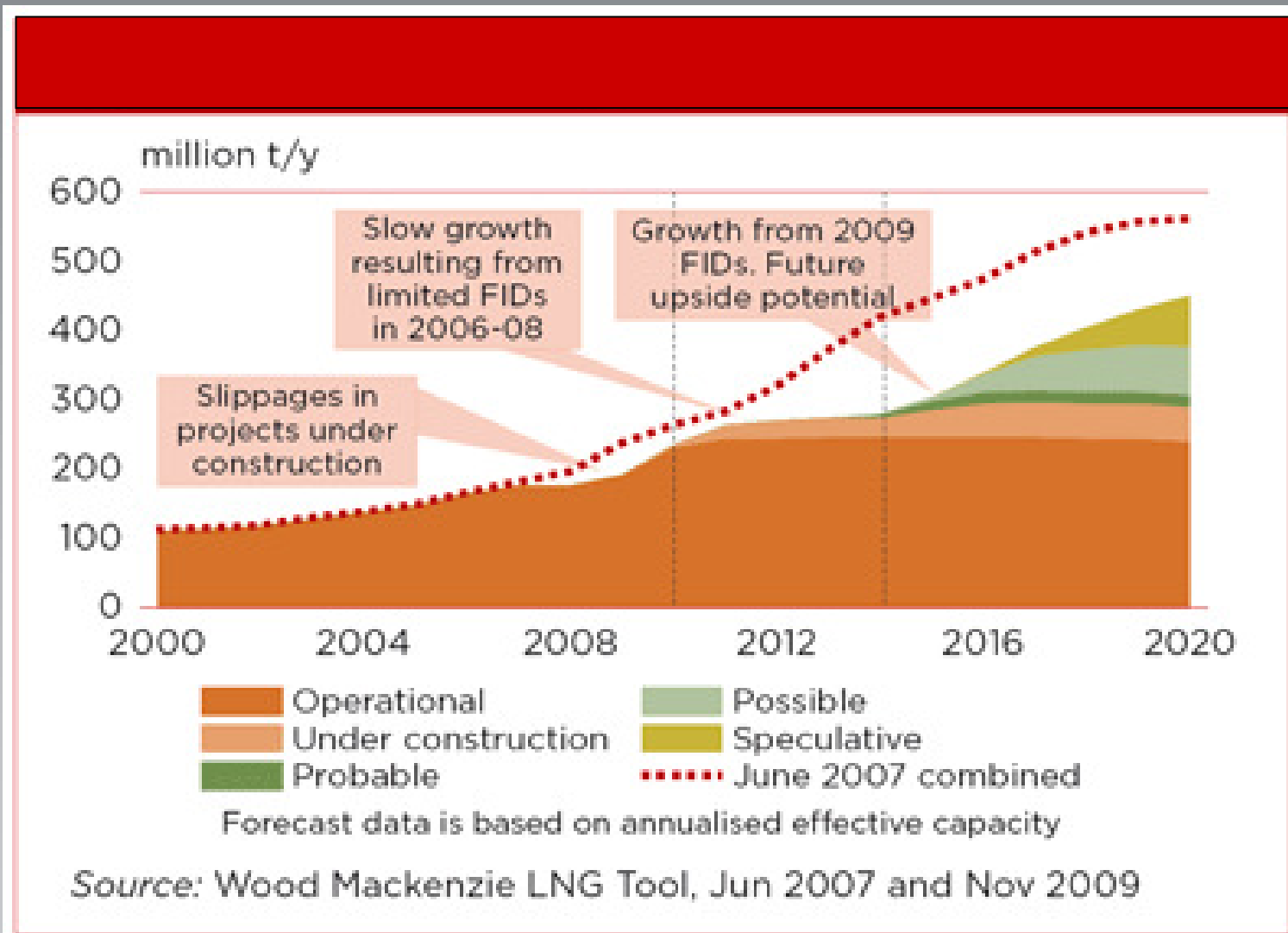



RAZVOJ KAPACITETA ZA UVOZ UPP-a U SJEVERNOJ AMERICI

RGNF

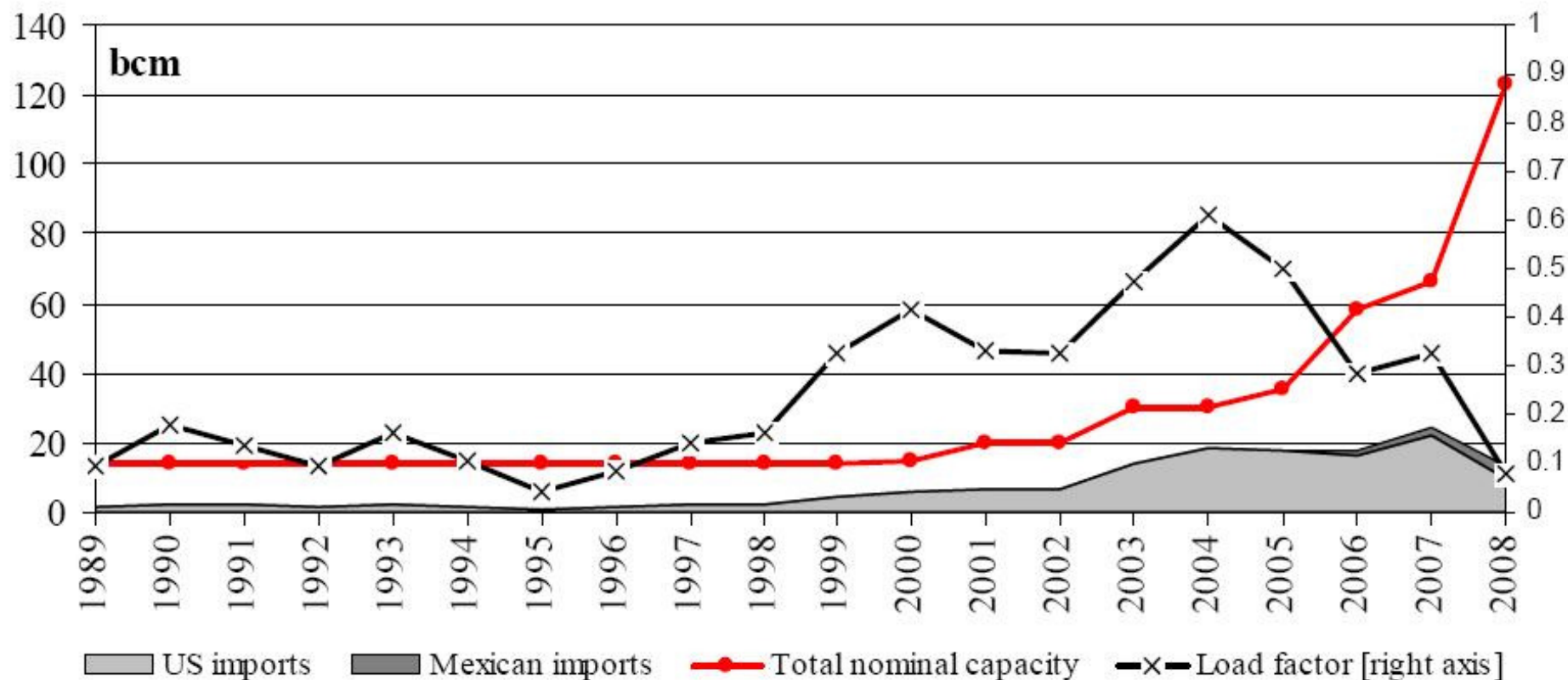

Sophia Ruester, Dresden University of Technology, www.energypolicyblog.com



OVOZNICI UPP-a – NOVA TRŽIŠTA

RGNF





PREDVIĐANJE PONUDE I POTRAŽNJE ZA UPP-om

RGNF

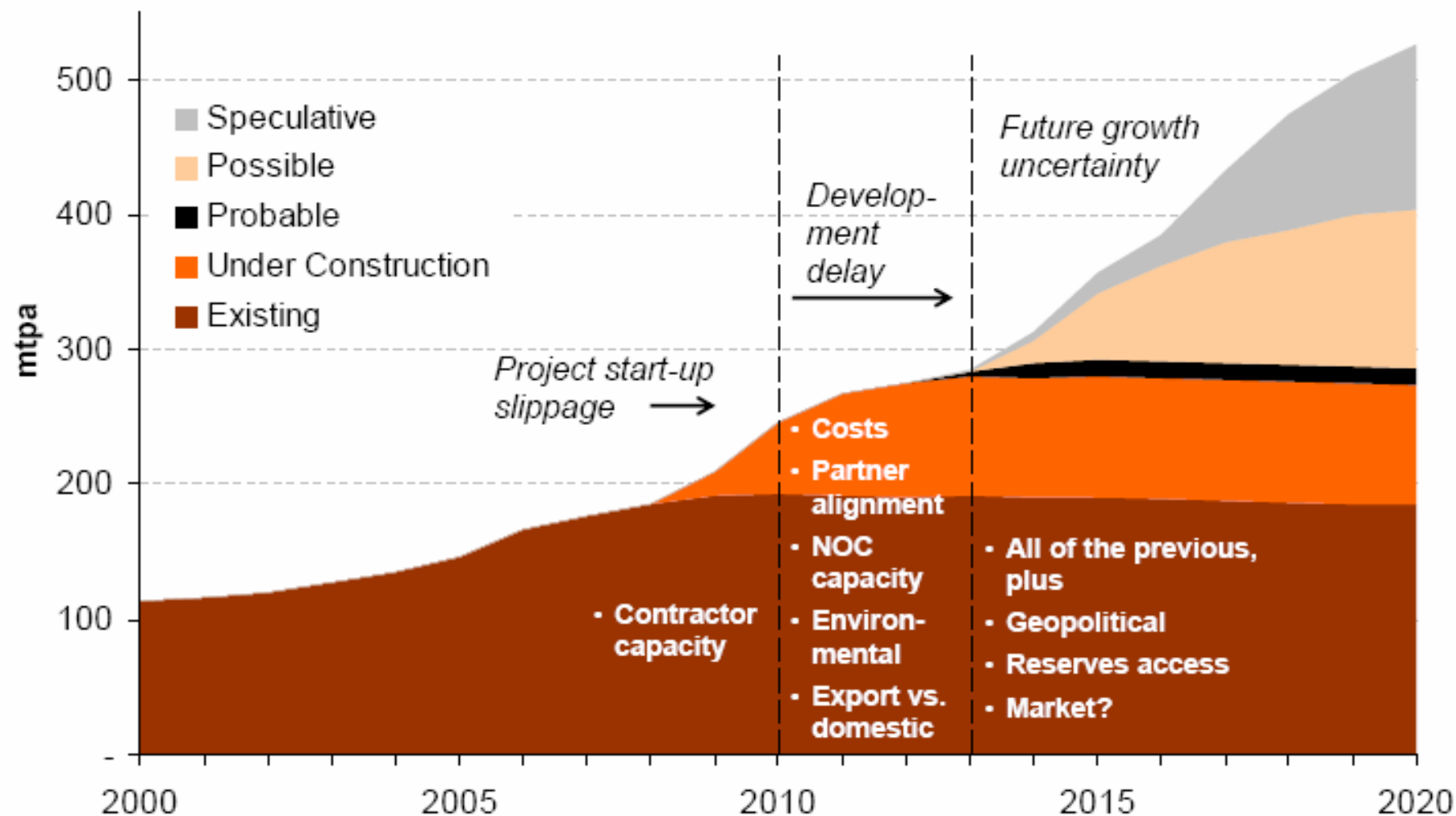

Source: BG Group interpretation of Wood Mackenzie data (Nov 2008)



PREDVIĐANJE PONUDE I POTRAŽNJE ZA UPP-om

RGNF

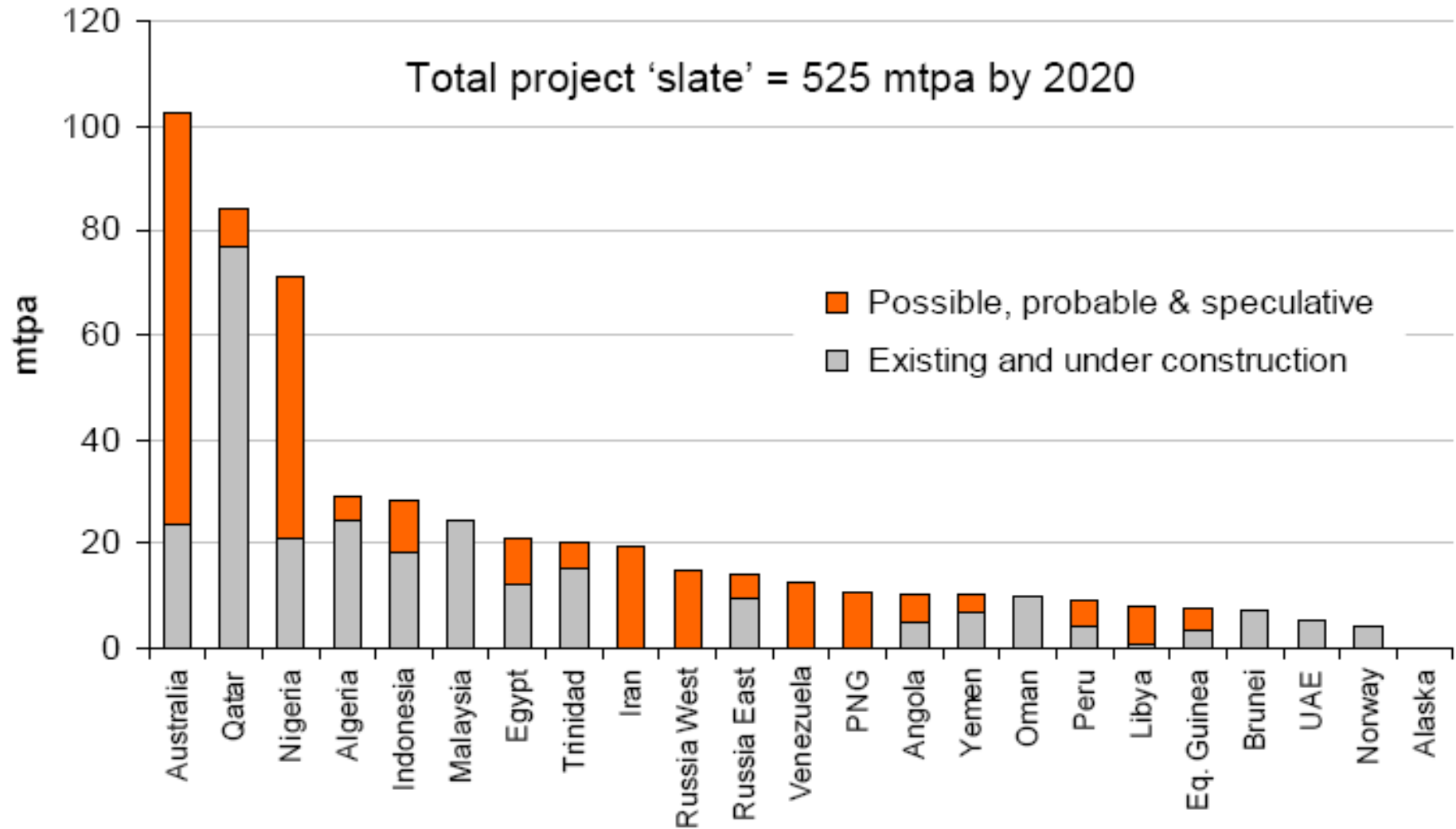

Source: Wood Mackenzie – Nov 08



CIJENE UPP-a NA SVJETSKOM TRŽIŠTU

RGNF

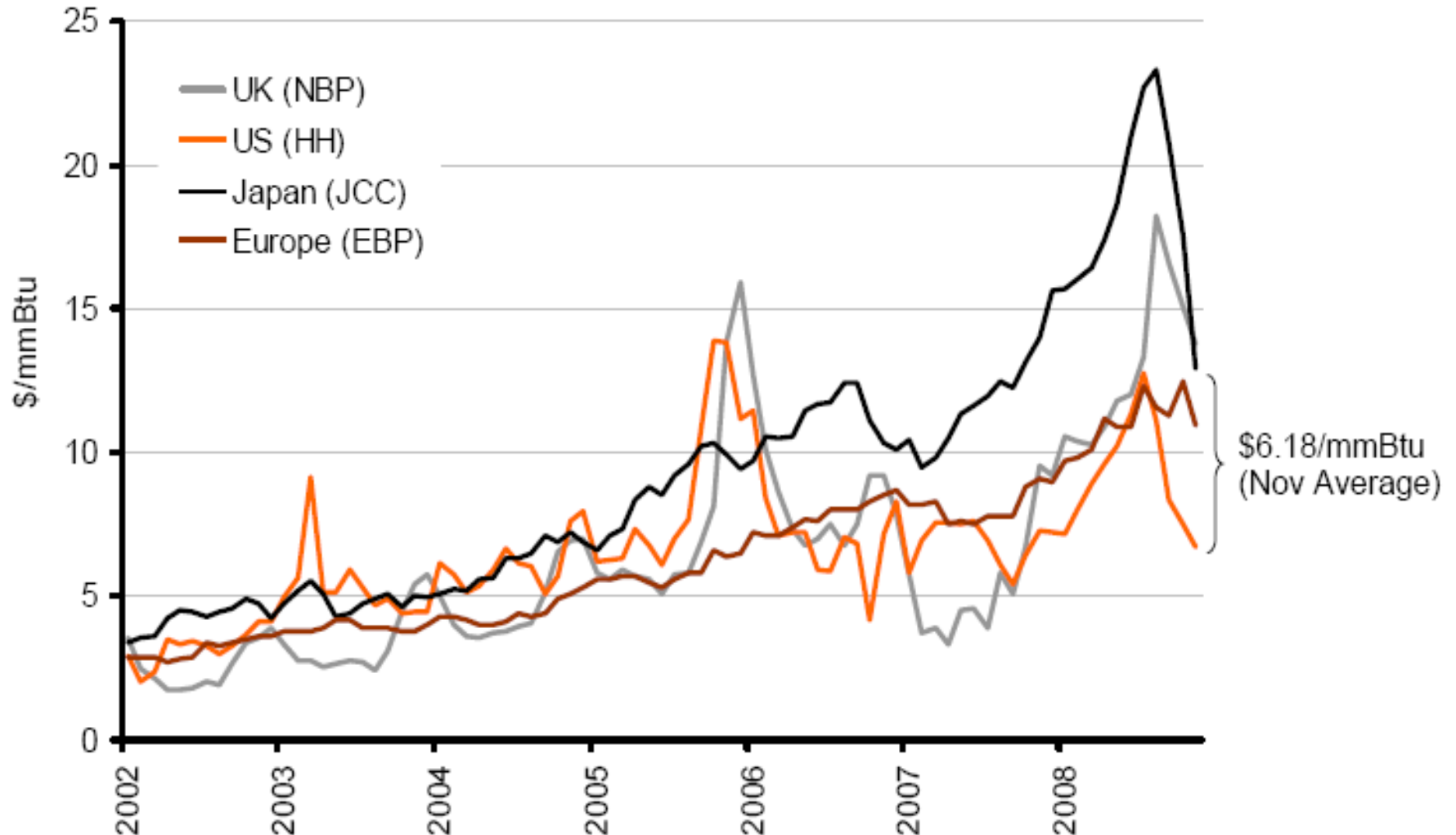

Data: JCC (Bloomberg), NBP (IPE), HH (NYMEX), EBP (BG Group internal)



LNG TERMINAL MARMARA ERGLESI (TURSKA)

RGNF





RGNF

LNG TERMINAL INCHEON (JUŽNA KOREJA)





RGNF

ISTAKAČKE RUKE



HVALA NA PAŽNJI!

